



# Octal, 14-Bit, Low-Power, High-Voltage Output, Serial Input DIGITAL-TO-ANALOG CONVERTER

 Check for Samples: [DAC8218](#)

## FEATURES

- **Bipolar Output:  $\pm 2V$  to  $\pm 16.5V$**
- **Unipolar Output:  $0V$  to  $+33V$**
- **14-Bit Resolution**
- **Low Power: 14.4mW/Ch (Bipolar Supply)**
- **Relative Accuracy: 1 LSB Max**
- **Low Zero/Full-Scale Error**
  - Before User Calibration:  $\pm 2.5$  LSB Max
  - After User Calibration:  $\pm 1$  LSB
- **Flexible System Calibration**
- **Low Glitch: 4nV-s**
- **Settling Time: 15 $\mu$ s**
- **Channel Monitor Output**
- **Programmable Gain: x4/x6**
- **Programmable Offset**
- **SPI™: Up to 50MHz, 1.8V/3V/5V Logic**
- **Schmitt Trigger Inputs**
- **Daisy-Chain with Sleep Mode Enhancement**
- **Packages: QFN-48 (7x7mm), TQFP-64 (10x10mm)**

## APPLICATIONS

- **Automatic Test Equipment**
- **PLC and Industrial Process Control**
- **Communications**

## DESCRIPTION

The DAC8218 is a low-power, octal, 14-bit digital-to-analog converter (DAC). With a 5V reference, the output can either be a bipolar  $\pm 15V$  voltage when operating from dual  $\pm 15.5V$  (or higher) power supplies, or a unipolar  $0V$  to  $+30V$  voltage when operating from a  $+30.5V$  (or higher) power supply. With a 5.5V reference, the output can either be a bipolar  $\pm 16.5V$  voltage when operating from dual  $\pm 17V$  (or higher) power supplies, or a unipolar  $0V$  to  $+33V$  voltage when operating from a  $+33.5V$  (or higher) power supply. This DAC provides low-power operation, good linearity, and low glitch over the specified temperature range of  $-40^{\circ}C$  to  $+105^{\circ}C$ . This device is trimmed in manufacturing and has very low zero-code and gain error. In addition, system level calibration can be performed to achieve  $\pm 1$  LSB bipolar zero/full-scale error with bipolar supplies, or  $\pm 1$  LSB zero code/full-scale error with a unipolar supply, over the entire signal chain. The output range can be offset by using the DAC offset register.

The DAC8218 features a standard, high-speed serial peripheral interface (SPI) that operates at up to 50MHz and is 1.8V, 3V, and 5V logic compatible, to communicate with a DSP or microprocessor. The input data of the device are double-buffered. An asynchronous load input ( $\overline{LDAC}$ ) transfers data from the DAC data register to the DAC latch. The asynchronous  $\overline{CLR}$  input sets the output of all eight DACs to the output of the individual analog outputs, the offset DAC, the reference buffer outputs, and two external inputs through a multiplexer (mux).

The DAC8218 is pin-to-pin and function-compatible with the [DAC8718](#) (16-bit) and the [DAC7718](#) (12-bit).

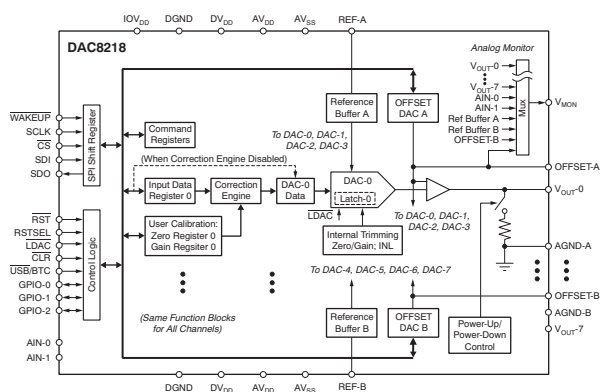

Please be aware that an important notice concerning availability, standard warranty, and use in critical applications of Texas Instruments semiconductor products and disclaimers thereto appears at the end of this data sheet.

DSP is a trademark of Texas Instruments.  
 SPI, QSPI are trademarks of Motorola Inc.  
 Microwire is a trademark of National Semiconductor.  
 All other trademarks are the property of their respective owners.



This integrated circuit can be damaged by ESD. Texas Instruments recommends that all integrated circuits be handled with appropriate precautions. Failure to observe proper handling and installation procedures can cause damage.

ESD damage can range from subtle performance degradation to complete device failure. Precision integrated circuits may be more susceptible to damage because very small parametric changes could cause the device not to meet its published specifications.

**ORDERING INFORMATION<sup>(1)</sup>**

| PRODUCT | RELATIVE ACCURACY (LSB) | DIFFERENTIAL LINEARITY (LSB) | PACKAGE-LEAD | PACKAGE DESIGNATOR | SPECIFIED TEMPERATURE RANGE | PACKAGE MARKING |
|---------|-------------------------|------------------------------|--------------|--------------------|-----------------------------|-----------------|
| DAC8218 | ±1                      | ±1                           | QFN-48       | RGZ                | -40°C to +105°C             | DAC8218         |
|         | ±1                      | ±1                           | TQFP-64      | PAG                | -40°C to +105°C             | DAC8218         |

(1) For the most current package and ordering information, see the Package Option Addendum at the end of this data sheet, or see the TI web site at [www.ti.com](http://www.ti.com).

**ABSOLUTE MAXIMUM RATINGS<sup>(1)</sup>**

Over operating free-air temperature range (unless otherwise noted).

|  | DAC8218                                 | UNIT   |           |
|--|---|--------|-----------|
| $AV_{DD}$ to $AV_{SS}$                       | -0.3 to 38                              | V      |           |
| $AV_{DD}$ to AGND                            | -0.3 to 38                              | V      |           |
| $AV_{SS}$ to AGND, DGND                      | -19 to 0.3                              | V      |           |
| $DV_{DD}$ to DGND                            | -0.3 to 6                               | V      |           |
| $IOV_{DD}$ to DGND                           | -0.3 to min of (6 or $DV_{DD} + 0.3$ )  | V      |           |
| AGND-x to DGND                               | -0.3 to 0.3                             | V      |           |
| Digital input voltage to DGND                | -0.3 to $IOV_{DD} + 0.3$                | V      |           |
| SDO to DGND                                  | -0.3 to $IOV_{DD} + 0.3$                | V      |           |
| $V_{OUT-x}$ , $V_{MON}$ , AIN-x to $AV_{SS}$ | -0.3 to $AV_{DD} + 0.3$                 | V      |           |
| REF-A, REF-B to AGND                         | -0.3 to $DV_{DD}$                       | V      |           |
| GPIO-n to DGND                               | -0.3 to $IOV_{DD} + 0.3$                | V      |           |
| GPIO-n input current                         | 5                                       | mA     |           |
| Maximum current from $V_{MON}$               | 3                                       | mA     |           |
| Operating temperature range                  | -40 to +105                             | °C     |           |
| Storage temperature range                    | -65 to +150                             | °C     |           |
| Maximum junction temperature ( $T_J$ max)    | +150                                    | °C     |           |
| ESD ratings                                  | Human body model (HBM)                  | 2.5 kV |           |
|  | Charged device model (CDM)              | 1000 V |           |
|  | Machine model (MM)                      | 200 V  |           |
| Thermal impedance                            | Junction-to-ambient, $\theta_{JA}$      | TQFP   | 55 °C/W   |
|  |   | QFN    | 27.5 °C/W |
|  | Junction-to-case, $\theta_{JC}$         | TQFP   | 21 °C/W   |
|  |   | QFN    | 10.8 °C/W |
| Power dissipation                            | $(T_J \text{ max} - T_A) / \theta_{JA}$ | W      |           |

(1) Stresses above those listed under *Absolute Maximum Ratings* may cause permanent damage to the device. Exposure to absolute maximum conditions for extended periods may affect device reliability.

## ELECTRICAL CHARACTERISTICS: Dual-Supply

All specifications at  $T_A = T_{MIN}$  to  $T_{MAX}$ ,  $AV_{DD} = +16.5V$ ,  $AV_{SS} = -16.5V$ ,  $IOV_{DD} = DV_{DD} = +5V$ , REF-A and REF-B = +5V, gain = 6, AGND-x = DGND = 0V, data format = straight binary, and Offset DAC A and Offset DAC B are at default values<sup>(1)</sup>, unless otherwise noted.

| PARAMETER                               | CONDITIONS  | DAC8218 |     |     | UNIT          |
|---|---|---------|-----|-----|---------------|
|   |   | MIN     | TYP | MAX |               |
| <b>STATIC PERFORMANCE<sup>(2)</sup></b> |   |         |     |     |               |
| Resolution                              |   | 14      |     |     | Bits          |
| Linearity error                         | Measured by line passing through codes 0000h and 3FFFh                      |         |     |     | ±1 LSB        |
| Differential linearity error            | Measured by line passing through codes 0000h and 3FFFh                      |         |     |     | ±1 LSB        |
| Bipolar zero error                      | $T_A = +25^\circ\text{C}$ , before user calibration, gain = 6, code = 2000h |         |     |     | ±2.5 LSB      |
|   | $T_A = +25^\circ\text{C}$ , before user calibration, gain = 4, code = 2000h |         |     |     | ±4 LSB        |
|   | $T_A = +25^\circ\text{C}$ , after user calib., gain = 4 or 6, code = 2000h  | ±1      |     |     | LSB           |
| Bipolar zero error TC                   | Gain = 4 or 6, code = 2000h   | ±0.5    |     |     | ±2 ppm FSR/°C |
| Zero-code error                         | $T_A = +25^\circ\text{C}$ , gain = 6, code = 0000h                          |         |     |     | ±2.5 LSB      |
|   | $T_A = +25^\circ\text{C}$ , gain = 4, code = 0000h                          |         |     |     | ±4 LSB        |
| Zero-code error TC                      | Gain = 4 or 6, code = 0000h   | ±0.5    |     |     | ±3 ppm FSR/°C |
| Gain error                              | $T_A = +25^\circ\text{C}$ , gain = 6  |         |     |     | ±2.5 LSB      |
|   | $T_A = +25^\circ\text{C}$ , gain = 4  |         |     |     | ±4 LSB        |
| Gain error TC                           | Gain = 4 or 6   | ±1      |     |     | ±3 ppm FSR/°C |
| Full-scale error                        | $T_A = +25^\circ\text{C}$ , before user calibration, gain = 6, code = 3FFFh |         |     |     | ±2.5 LSB      |
|   | $T_A = +25^\circ\text{C}$ , before user calibration, gain = 4, code = 3FFFh |         |     |     | ±4 LSB        |
|   | $T_A = +25^\circ\text{C}$ , after user calib., gain = 4 or 6, code = 3FFFh  | ±1      |     |     | LSB           |
| Full-scale error TC                     | Gain = 4 or 6, code = 3FFFh   | ±0.5    |     |     | ±3 ppm FSR/°C |
| DC crosstalk <sup>(3)</sup>             | Measured channel at code = 2000h, full-scale change on any other channel    | 0.05    |     |     | LSB           |

- (1) Offset DAC A and Offset DAC B are trimmed in manufacturing to minimize the error for symmetrical output. The default value may vary no more than ±3 LSB from the nominal number listed in [Table 7](#). The Offset DAC pins are not intended to drive an external load, and must not be connected during dual-supply operation.
- (2) Gain = 4 and TC specified by design and characterization.
- (3) The DAC outputs are buffered by op amps that share common  $AV_{DD}$  and  $AV_{SS}$  power supplies. DC crosstalk indicates how much dc change in one or more channel outputs may occur when the dc load current changes in one channel (because of an update). With high-impedance loads, the effect is virtually immeasurable. Multiple  $AV_{DD}$  and  $AV_{SS}$  terminals are provided to minimize dc crosstalk.

## ELECTRICAL CHARACTERISTICS: Dual-Supply (continued)

All specifications at  $T_A = T_{MIN}$  to  $T_{MAX}$ ,  $AV_{DD} = +16.5V$ ,  $AV_{SS} = -16.5V$ ,  $IOV_{DD} = DV_{DD} = +5V$ , REF-A and REF-B = +5V, gain = 6, AGND-x = DGND = 0V, data format = straight binary, and Offset DAC A and Offset DAC B are at default values <sup>(1)</sup>, unless otherwise noted.

| PARAMETER   | CONDITIONS   | DAC8218 |         |      | UNIT            |
|---|--|---------|---------|------|-----------------|
|   |  | MIN     | TYP     | MAX  |                 |
| <b>ANALOG OUTPUT (<math>V_{OUT-0}</math> to <math>V_{OUT-7}</math>)<sup>(4)</sup></b> |  |         |         |      |                 |
| Voltage output <sup>(5)</sup>   | $V_{REF} = +5V$  | -15     |         | +15  | V               |
|   | $V_{REF} = +1.5V$  | -4.5    |         | +4.5 | V               |
| Output impedance  | Code = 2000h   |         |         | 0.5  | $\Omega$        |
| Short-circuit current <sup>(6)</sup>  |  |         | $\pm 8$ |      | mA              |
| Load current  | See <a href="#">Figure 37</a>  |         | $\pm 3$ |      | mA              |
| Output drift vs time  | $T_A = +25^\circ C$ , device operating for 500 hours, full-scale output                          |         | 3.4     |      | ppm of FSR      |
|   | $T_A = +25^\circ C$ , device operating for 1000 hours, full-scale output                         |         | 4.3     |      | ppm of FSR      |
| Capacitive load stability   |  |         |         | 500  | pF              |
| Settling time   | To 0.03% of FSR, $C_L = 200pF$ , $R_L = 10k\Omega$ , code from 0000h to 3FFFh and 3FFFh to 0000h |         | 10      |      | $\mu s$         |
|   | To 1 LSB, $C_L = 200pF$ , $R_L = 10k\Omega$ , code from 0000h to 3FFFh and 3FFFh to 0000h        |         | 15      |      | $\mu s$         |
|   | To 1 LSB, $C_L = 200pF$ , $R_L = 10k\Omega$ , code from 1FC0h to 2040h and 2040h to 1FC0h        |         | 6       |      | $\mu s$         |
| Slew rate <sup>(7)</sup>  |  |         | 6       |      | V/ $\mu s$      |
| Power-on delay <sup>(8)</sup>   | From $IOV_{DD} \geq +1.8V$ and $DV_{DD} \geq +2.7V$ to $\overline{CS}$ low                       |         | 200     |      | $\mu s$         |
| Power-down recovery time  |  |         | 60      |      | $\mu s$         |
| Digital-to-analog glitch <sup>(9)</sup>   | Code from 1FFFh to 2000h and 2000h to 1FFFh  |         | 4       |      | nV-s            |
| Glitch impulse peak amplitude   | Code from 1FFFh to 2000h and 2000h to 1FFFh  |         | 5       |      | mV              |
| Channel-to-channel isolation <sup>(10)</sup>  | $V_{REF} = 4V_{PP}$ , $f = 1kHz$   |         | 88      |      | dB              |
| DAC-to-DAC crosstalk <sup>(11)</sup>  | DACs in the same group   |         | 7.5     |      | nV-s            |
|   | DACs among different groups  |         | 1       |      | nV-s            |
| Digital crosstalk <sup>(12)</sup>   |  |         | 1       |      | nV-s            |
| Digital feedthrough <sup>(13)</sup>   |  |         | 1       |      | nV-s            |
| Output noise  | $T_A = +25^\circ C$ at 10kHz, gain = 6   |         | 200     |      | nV/ $\sqrt{Hz}$ |
|   | $T_A = +25^\circ C$ at 10kHz, gain = 4   |         | 130     |      | nV/ $\sqrt{Hz}$ |
|   | 0.1Hz to 10Hz, gain = 6  |         | 20      |      | $\mu V_{PP}$    |
| Power-supply rejection <sup>(14)</sup>  | $AV_{DD} = \pm 15.5V$ to $\pm 16.5V$   |         | 0.05    |      | LSB             |

- (4) Specified by design.
- (5) The analog output range of  $V_{OUT-0}$  to  $V_{OUT-7}$  is equal to  $(6 \times V_{REF} - 5 \times OUTPUT\_OFFSET\_DAC)$  for gain = 6. The maximum value of the analog output must not be greater than  $(AV_{DD} - 0.5V)$ , and the minimum value must not be less than  $(AV_{SS} + 0.5V)$ . All specifications are for a  $\pm 16.5V$  power supply and a  $\pm 15V$  output, unless otherwise noted.
- (6) When the output current is greater than the specification, the current is clamped at the specified maximum value.
- (7) Slew rate is measured from 10% to 90% of the transition when the output changes from 0 to full-scale.
- (8) *Power-on delay* is defined as the time from when the supply voltages reach the specified conditions to when  $\overline{CS}$  goes low, for valid digital communication.
- (9) *Digital-to-analog glitch* is defined as the amount of energy injected into the analog output at the major code transition. It is specified as the area of the glitch in nV-s. It is measured by toggling the DAC register data between 1FFFh and 2000h in straight binary format.
- (10) *Channel-to-channel isolation* refers to the ratio of the signal amplitude at the output of one DAC channel to the amplitude of the sinusoidal signal on the reference input of another DAC channel. It is expressed in dB and measured at midscale.
- (11) *DAC-to-DAC crosstalk* is the glitch impulse that appears at the output of one DAC as a result of both the full-scale digital code and subsequent analog output change at another DAC. It is measured with LDAC tied low and expressed in nV-s.
- (12) *Digital crosstalk* is the glitch impulse transferred to the output of one converter as a result of a full-scale code change in the DAC input register of another converter. It is measured when the DAC output is not updated, and is expressed in nV-s.
- (13) *Digital feedthrough* is the glitch impulse injected to the output of a DAC as a result of a digital code change in the DAC input register of the same DAC. It is measured with the full-scale digital code change without updating the DAC output, and is expressed in nV-s.
- (14) The output must not be greater than  $(AV_{DD} - 0.5V)$  and not less than  $(AV_{SS} + 0.5V)$ .

**ELECTRICAL CHARACTERISTICS: Dual-Supply (continued)**

All specifications at  $T_A = T_{MIN}$  to  $T_{MAX}$ ,  $AV_{DD} = +16.5V$ ,  $AV_{SS} = -16.5V$ ,  $IOV_{DD} = DV_{DD} = +5V$ , REF-A and REF-B = +5V, gain = 6, AGND-x = DGND = 0V, data format = straight binary, and Offset DAC A and Offset DAC B are at default values <sup>(1)</sup>, unless otherwise noted.

| PARAMETER   | CONDITIONS  | DAC8218                |           |                  | UNIT       |
|---|---|------------------------|-----------|------------------|------------|
|   |   | MIN                    | TYP       | MAX              |            |
| <b>OFFSET DAC OUTPUT<sup>(15)</sup> <sup>(16)</sup></b> |   |                        |           |                  |            |
| Voltage output  | $V_{REF} = +5V$   | 0                      |           | 5                | V          |
| Full-scale error  | $T_A = +25^\circ C$   |                        | $\pm 1$   |                  | LSB        |
| Zero-code error   | $T_A = +25^\circ C$   |                        | $\pm 0.5$ |                  | LSB        |
| Linearity error   |   |                        | $\pm 1.5$ |                  | LSB        |
| Differential linearity error                            |   |                        |           | $\pm 1$          | LSB        |
| <b>ANALOG MONITOR PIN (<math>V_{MON}</math>)</b>        |   |                        |           |                  |            |
| Output impedance <sup>(17)</sup>                        | $T_A = +25^\circ C$   |                        | 2         |                  | k $\Omega$ |
| Three-state leakage current                             |   |                        | 100       |                  | nA         |
| <b>AUXILIARY ANALOG INPUT</b>                           |   |                        |           |                  |            |
| Input range   |   | $AV_{SS}$              |           | $AV_{DD}$        | V          |
| Input impedance<br>(AIN-x to $V_{MON}$ )                | $T_A = +25^\circ C$   |                        | 2         |                  | k $\Omega$ |
| Input capacitance <sup>(15)</sup>                       |   |                        | 4         |                  | pF         |
| Input leakage current                                   |   |                        | 30        |                  | nA         |
| <b>REFERENCE INPUT</b>                                  |   |                        |           |                  |            |
| Reference input voltage range <sup>(18)</sup>           |   | 1.0                    |           | 5.5              | V          |
| Reference input dc impedance                            |   |                        | 10        |                  | M $\Omega$ |
| Reference input capacitance <sup>(15)</sup>             |   |                        | 10        |                  | pF         |
| <b>DIGITAL INPUT<sup>(15)</sup></b>                     |   |                        |           |                  |            |
| High-level input voltage, $V_{IH}$                      | $IOV_{DD} = +4.5V$ to $+5.5V$   | 3.8                    |           | $0.3 + IOV_{DD}$ | V          |
|   | $IOV_{DD} = +2.7V$ to $+3.3V$   | 2.3                    |           | $0.3 + IOV_{DD}$ | V          |
|   | $IOV_{DD} = +1.7V$ to $2.0V$  | 1.5                    |           | $0.3 + IOV_{DD}$ | V          |
| Low-level input voltage, $V_{IL}$                       | $IOV_{DD} = +4.5V$ to $+5.5V$   | -0.3                   |           | 0.8              | V          |
|   | $IOV_{DD} = +2.7V$ to $+3.3V$   | -0.3                   |           | 0.6              | V          |
|   | $IOV_{DD} = +1.7V$ to $2.0V$  | -0.3                   |           | 0.3              | V          |
| Input current   | $\overline{CLR}$ , LDAC, $\overline{RST}$ , $\overline{CS}$ , and SDI |                        |           | $\pm 1$          | $\mu A$    |
|   | $\overline{USB/BTC}$ , RSTSEL, and GPIO-n                             |                        |           | $\pm 5$          | $\mu A$    |
| Input capacitance                                       | $\overline{CLR}$ , LDAC, $\overline{RST}$ , $\overline{CS}$ , and SDI |                        | 5         |                  | pF         |
|   | $\overline{USB/BTC}$ and RSTSEL                                       |                        | 12        |                  | pF         |
|   | GPIO-n  |                        | 14        |                  | pF         |
| <b>DIGITAL OUTPUT<sup>(15)</sup></b>                    |   |                        |           |                  |            |
| High-level output voltage, $V_{OH}$<br>(SDO)            | $IOV_{DD} = +2.7V$ to $+5.5V$ , sourcing 1mA                          | $IOV_{DD} - 0.4$       |           | $IOV_{DD}$       | V          |
|   | $IOV_{DD} = +1.8V$ , sourcing 200 $\mu A$                             | 1.6                    |           | $IOV_{DD}$       | V          |
| Low-level output voltage, $V_{OL}$<br>(SDO)             | $IOV_{DD} = +2.7V$ to $+5.5V$ , sinking 1mA                           | 0                      |           | 0.4              | V          |
|   | $IOV_{DD} = +1.8V$ , sinking 200 $\mu A$                              | 0                      |           | 0.2              | V          |
| GPIO-n output voltage low, $V_{OL}$                     | 1mA sink from $IOV_{DD}$  |                        | 0.15      |                  | V          |
| GPIO-n output voltage high, $V_{OH}$                    | 10k $\Omega$ pull-up resistor to $IOV_{DD}$                           | $0.99 \times IOV_{DD}$ |           |                  | V          |
| High-impedance leakage current                          | SDO and GPIO-n  |                        | $\pm 5$   |                  | $\mu A$    |
| High-impedance output<br>capacitance                    | SDO   |                        | 5         |                  | pF         |
|   | GPIO-n  |                        | 14        |                  | pF         |

(15) Specified by design.

(16) Offset DAC A and Offset DAC B are trimmed in manufacturing to minimize the error for symmetrical output. The default value may vary no more than  $\pm 3$  LSB from the nominal number listed in Table 7. The Offset DAC pins are not intended to drive an external load, and must not be connected during dual-supply operation.

(17) 8k $\Omega$  when  $V_{MON}$  is connected to Reference Buffer A or B, and 4k $\Omega$  when  $V_{MON}$  is connected to Offset DAC-A or -B.

(18) Reference input voltage  $\leq DV_{DD}$ .

### ELECTRICAL CHARACTERISTICS: Dual-Supply (continued)

All specifications at  $T_A = T_{MIN}$  to  $T_{MAX}$ ,  $AV_{DD} = +16.5V$ ,  $AV_{SS} = -16.5V$ ,  $IOV_{DD} = DV_{DD} = +5V$ , REF-A and REF-B = +5V, gain = 6, AGND-x = DGND = 0V, data format = straight binary, and Offset DAC A and Offset DAC B are at default values <sup>(1)</sup>, unless otherwise noted.

| PARAMETER                  | CONDITIONS  | DAC8218 |      |      | UNIT         |
|----------------------------|---|---------|------|------|--------------|
|                            |   | MIN     | TYP  | MAX  |              |
| <b>POWER SUPPLY</b>        |   |         |      |      |              |
| $AV_{DD}$                  |   | +4.5    |      | +18  | V            |
| $AV_{SS}$                  |   | -18     |      | -4.5 | V            |
| $DV_{DD}$                  |   | +2.7    |      | +5.5 | V            |
| $IOV_{DD}$ <sup>(19)</sup> |   | +1.8    |      | +5.5 | V            |
| $AI_{DD}$                  | Normal operation, midscale code, output unloaded        |         | 4.3  | 6    | mA           |
|                            | Power down, output unloaded                             |         | 35   |      | $\mu$ A      |
| $AI_{SS}$                  | Normal operation, midscale code, output unloaded        | -4      | -2.7 |      | mA           |
|                            | Power down, output unloaded                             |         | 35   |      | $\mu$ A      |
| $DI_{DD}$                  | Normal operation  |         | 78   |      | $\mu$ A      |
|                            | Power down  |         | 36   |      | $\mu$ A      |
| $IOI_{DD}$                 | Normal operation, $V_{IH} = IOV_{DD}$ , $V_{IL} = DGND$ |         | 5    |      | $\mu$ A      |
|                            | Power down, $V_{IH} = IOV_{DD}$ , $V_{IL} = DGND$       |         | 5    |      | $\mu$ A      |
| Power dissipation          | Normal operation, $\pm 16.5V$ supplies, midscale code   |         | 115  | 165  | mW           |
| <b>TEMPERATURE RANGE</b>   |   |         |      |      |              |
| Specified performance      |   | -40     |      | +105 | $^{\circ}$ C |

(19)  $IOV_{DD} \leq DV_{DD}$ .

## ELECTRICAL CHARACTERISTICS: Single-Supply

All specifications at  $T_A = T_{MIN}$  to  $T_{MAX}$ ,  $AV_{DD} = +32V$ ,  $AV_{SS} = 0V$ ,  $IOV_{DD} = DV_{DD} = +5V$ , REF-A and REF-B = +5V, gain = 6, AGND-x = DGND = 0V, data format = straight binary, and OFFSET-A = OFFSET-B = AGND, unless otherwise noted.

| PARAMETER   | CONDITIONS   | DAC8218 |      |      | UNIT       |
|---|--|---------|------|------|------------|
|   |  | MIN     | TYP  | MAX  |            |
| <b>STATIC PERFORMANCE<sup>(1)</sup></b>   |  |         |      |      |            |
| Resolution  |  | 14      |      |      | Bits       |
| Linearity error   | Measured by line passing through codes 0040h and 3FFFh   |         |      | ±1   | LSB        |
| Differential linearity error  | Measured by line passing through codes 0040h and 3FFFh   |         |      | ±1   | LSB        |
| Unipolar zero error   | $T_A = +25^\circ\text{C}$ , before user calibration, gain = 6, code = 0040h                                    |         |      | ±2.5 | LSB        |
|   | $T_A = +25^\circ\text{C}$ , before user calibration, gain = 4, code = 0040h                                    |         |      | ±4   | LSB        |
|   | $T_A = +25^\circ\text{C}$ , after user calib., gain = 4 or 6, code = 0040h                                     |         | ±1   |      | LSB        |
| Unipolar zero error TC  | Gain = 4 or 6, code = 0040h  |         | ±0.5 | ±3   | ppm FSR/°C |
| Gain error  | $T_A = +25^\circ\text{C}$ , gain = 6   |         |      | ±2.5 | LSB        |
|   | $T_A = +25^\circ\text{C}$ , gain = 4   |         |      | ±4   | LSB        |
| Gain error TC   | Gain = 4 or 6  |         | ±1   | ±3   | ppm FSR/°C |
| Full-scale error  | $T_A = +25^\circ\text{C}$ , before user calibration, gain = 6, code = 3FFFh                                    |         |      | ±2.5 | LSB        |
|   | $T_A = +25^\circ\text{C}$ , before user calibration, gain = 4, code = 3FFFh                                    |         |      | ±4   | LSB        |
|   | $T_A = +25^\circ\text{C}$ , after user calib., gain = 4 or 6, code = 3FFFh                                     |         | ±1   |      | LSB        |
| Full-scale error TC   | Gain = 4 or 6, code = 3FFFh  |         | ±0.5 | ±3   | ppm FSR/°C |
| DC crosstalk <sup>(2)</sup>   | Measured channel at code = 2000h, full-scale change on any other channel                                       |         | 0.05 |      | LSB        |
| <b>ANALOG OUTPUT (<math>V_{OUT-0}</math> to <math>V_{OUT-7}</math>)<sup>(3)</sup></b> |  |         |      |      |            |
| Voltage output <sup>(4)</sup>   | $V_{REF} = +5V$  | 0       |      | +30  | V          |
|   | $V_{REF} = +1.5V$  | 0       |      | +9   | V          |
| Output impedance  | Code = 2000h   |         |      | 0.5  | Ω          |
| Short-circuit current <sup>(5)</sup>  |  |         | ±8   |      | mA         |
| Load current  | See <a href="#">Figure 84</a> and <a href="#">Figure 85</a>  |         | ±3   |      | mA         |
| Output drift vs time  | $T_A = +25^\circ\text{C}$ , device operating for 500 hours, full-scale output                                  |         | 3.4  |      | ppm of FSR |
|   | $T_A = +25^\circ\text{C}$ , device operating for 1000 hours, full-scale output                                 |         | 4.3  |      | ppm of FSR |
| Capacitive load stability   |  |         |      | 500  | pF         |
| Settling time   | To 0.03% of FSR, $C_L = 200\text{pF}$ , $R_L = 10\text{k}\Omega$ , code from 0040h to 3FFFh and 3FFFh to 0040h |         | 10   |      | μs         |
|   | To 1 LSB, $C_L = 200\text{pF}$ , $R_L = 10\text{k}\Omega$ , code from 0040h to 3FFFh and 3FFFh to 0040h        |         | 15   |      | μs         |
|   | To 1 LSB, $C_L = 200\text{pF}$ , $R_L = 10\text{k}\Omega$ , code from 1FC0h to 2040h and 2040h to 1FC0h        |         | 6    |      | μs         |
| Slew rate <sup>(6)</sup>  |  |         | 6    |      | V/μs       |
| Power-on delay <sup>(7)</sup>   | From $IOV_{DD} \geq +1.8V$ and $DV_{DD} \geq +2.7V$ to $\overline{CS}$ low                                     |         | 200  |      | μs         |
| Power-down recovery time  |  |         | 90   |      | μs         |
| Digital-to-analog glitch <sup>(8)</sup>   | Code from 1FFFh to 2000h and 2000h to 1FFFh  |         | 4    |      | nV-s       |
| Glitch impulse peak amplitude   | Code from 1FFFh to 2000h and 2000h to 1FFFh  |         | 5    |      | mV         |
| Channel-to-channel isolation <sup>(9)</sup>   | $V_{REF} = 4V_{PP}$ , $f = 1\text{kHz}$  |         | 88   |      | dB         |

- (1) Gain = 4 and TC specified by design and characterization.
- (2) The DAC outputs are buffered by op amps that share common  $AV_{DD}$  and  $AV_{SS}$  power supplies. DC crosstalk indicates how much dc change in one or more channel outputs may occur when the dc load current changes in one channel (because of an update). With high-impedance loads, the effect is virtually immeasurable. Multiple  $AV_{DD}$  and  $AV_{SS}$  terminals are provided to minimize dc crosstalk.
- (3) Specified by design.
- (4) The analog output range of  $V_{OUT-0}$  to  $V_{OUT-7}$  is equal to  $(6 \times V_{REF})$  for gain = 6. The maximum value of the analog output must not be greater than  $(AV_{DD} - 0.5V)$ . All specifications are for a +32V power supply and a 0V to +30V output, unless otherwise noted.
- (5) When the output current is greater than the specification, the current is clamped at the specified maximum value.
- (6) Slew rate is measured from 10% to 90% of the transition when the output changes from 0 to full-scale.
- (7) *Power-on delay* is defined as the time from when the supply voltages reach the specified conditions to when  $\overline{CS}$  goes low, for valid digital communication.
- (8) *Digital-to-analog glitch* is defined as the amount of energy injected into the analog output at the major code transition. It is specified as the area of the glitch in nV-s. It is measured by toggling the DAC register data between 1FFFh and 2000h in straight binary format.
- (9) *Channel-to-channel isolation* refers to the ratio of the signal amplitude at the output of one DAC channel to the amplitude of the sinusoidal signal on the reference input of another DAC channel. It is expressed in dB and measured at midscale.

## ELECTRICAL CHARACTERISTICS: Single-Supply (continued)

All specifications at  $T_A = T_{MIN}$  to  $T_{MAX}$ ,  $AV_{DD} = +32V$ ,  $AV_{SS} = 0V$ ,  $IOV_{DD} = DV_{DD} = +5V$ , REF-A and REF-B = +5V, gain = 6, AGND-x = DGND = 0V, data format = straight binary, and OFFSET-A = OFFSET-B = AGND, unless otherwise noted.

| PARAMETER  | CONDITIONS  | DAC8218   |      |                  | UNIT                   |
|--|---|-----------|------|------------------|------------------------|
|  |   | MIN       | TYP  | MAX              |                        |
| DAC-to-DAC crosstalk <sup>(10)</sup>             | DACs in the same group  |           | 10   |                  | nV-s                   |
|  | DACs among different groups   |           | 1    |                  | nV-s                   |
| Digital crosstalk <sup>(11)</sup>                |   |           | 1    |                  | nV-s                   |
| Digital feedthrough <sup>(12)</sup>              |   |           | 1    |                  | nV-s                   |
| Output noise                                     | $T_A = +25^\circ\text{C}$ at 10kHz, gain = 6  |           | 200  |                  | nV/ $\sqrt{\text{Hz}}$ |
|  | $T_A = +25^\circ\text{C}$ at 10kHz, gain = 4  |           | 130  |                  | nV/ $\sqrt{\text{Hz}}$ |
|  | 0.1Hz to 10Hz, gain = 6   |           | 20   |                  | $\mu\text{V}_{PP}$     |
| Power-supply rejection <sup>(13)</sup>           | $AV_{DD} = +33V$ to +36V  |           | 0.05 |                  | LSB                    |
| <b>ANALOG MONITOR PIN (<math>V_{MON}</math>)</b> |   |           |      |                  |                        |
| Output impedance <sup>(14)</sup>                 | $T_A = +25^\circ\text{C}$   |           | 2    |                  | k $\Omega$             |
| Three-state leakage current                      |   |           | 100  |                  | nA                     |
| <b>AUXILIARY ANALOG INPUT</b>                    |   |           |      |                  |                        |
| Input range                                      |   | $AV_{SS}$ |      | $AV_{DD}$        | V                      |
| Input impedance (AIN-x to $V_{MON}$ )            | $T_A = +25^\circ\text{C}$   |           | 2    |                  | k $\Omega$             |
| Input capacitance <sup>(15)</sup>                |   |           | 4    |                  | pF                     |
| Input leakage current                            |   |           | 30   |                  | nA                     |
| <b>REFERENCE INPUT</b>                           |   |           |      |                  |                        |
| Reference input voltage range <sup>(16)</sup>    |   | 1.0       |      | 5.5              | V                      |
| Reference input dc impedance                     |   |           | 10   |                  | M $\Omega$             |
| Reference input capacitance <sup>(15)</sup>      |   |           | 10   |                  | pF                     |
| <b>DIGITAL INPUT<sup>(15)</sup></b>              |   |           |      |                  |                        |
| High-level input voltage, $V_{IH}$               | $IOV_{DD} = +4.5V$ to +5.5V   | 3.8       |      | $0.3 + IOV_{DD}$ | V                      |
|  | $IOV_{DD} = +2.7V$ to +3.3V   | 2.3       |      | $0.3 + IOV_{DD}$ | V                      |
|  | $IOV_{DD} = +1.7V$ to 2.0V  | 1.5       |      | $0.3 + IOV_{DD}$ | V                      |
| Low-level input voltage, $V_{IL}$                | $IOV_{DD} = +4.5V$ to +5.5V   | -0.3      |      | 0.8              | V                      |
|  | $IOV_{DD} = +2.7V$ to +3.3V   | -0.3      |      | 0.6              | V                      |
|  | $IOV_{DD} = +1.7V$ to 2.0V  | -0.3      |      | 0.3              | V                      |
| Input current                                    | $\overline{\text{CLR}}$ , $\overline{\text{LDAC}}$ , $\overline{\text{RST}}$ , $\overline{\text{CS}}$ , and SDI |           |      | $\pm 1$          | $\mu\text{A}$          |
|  | $\overline{\text{USB/BTC}}$ , RSTSEL, and GPIO-n  |           |      | $\pm 5$          | $\mu\text{A}$          |
| Input capacitance                                | $\overline{\text{CLR}}$ , $\overline{\text{LDAC}}$ , $\overline{\text{RST}}$ , $\overline{\text{CS}}$ , and SDI |           | 5    |                  | pF                     |
|  | $\overline{\text{USB/BTC}}$ and RSTSEL  |           | 12   |                  | pF                     |
|  | GPIO-n  |           | 14   |                  | pF                     |

(10) DAC-to-DAC crosstalk is the glitch impulse that appears at the output of one DAC as a result of both the full-scale digital code and subsequent analog output change at another DAC. It is measured with LDAC tied low and expressed in nV-s.

(11) Digital crosstalk is the glitch impulse transferred to the output of one converter as a result of a full-scale code change in the DAC input register of another converter. It is measured when the DAC output is not updated, and is expressed in nV-s.

(12) Digital feedthrough is the glitch impulse injected to the output of a DAC as a result of a digital code change in the DAC input register of the same DAC. It is measured with the full-scale digital code change without updating the DAC output, and is expressed in nV-s.

(13) The analog output must not be greater than  $(AV_{DD} - 0.5V)$ .

(14) 8k $\Omega$  when  $V_{MON}$  is connected to Reference Buffer A or B, and 4k $\Omega$  when  $V_{MON}$  is connected to Offset DAC-A or -B.

(15) Specified by design.

(16) Reference input voltage  $\leq DV_{DD}$ .



**ELECTRICAL CHARACTERISTICS: Single-Supply (continued)**

All specifications at  $T_A = T_{MIN}$  to  $T_{MAX}$ ,  $AV_{DD} = +3.2V$ ,  $AV_{SS} = 0V$ ,  $IOV_{DD} = DV_{DD} = +5V$ , REF-A and REF-B = +5V, gain = 6, AGND-x = DGND = 0V, data format = straight binary, and OFFSET-A = OFFSET-B = AGND, unless otherwise noted.

| PARAMETER                                 | CONDITIONS  | DAC8218                |         |            | UNIT         |
|---|---|------------------------|---------|------------|--------------|
|   |   | MIN                    | TYP     | MAX        |              |
| <b>DIGITAL OUTPUT<sup>(17)</sup></b>      |   |                        |         |            |              |
| High-level output voltage, $V_{OH}$ (SDO) | $IOV_{DD} = +2.7V$ to $+5.5V$ , sourcing 1mA            | $IOV_{DD} - 0.4$       |         | $IOV_{DD}$ | V            |
|   | $IOV_{DD} = +1.8V$ , sourcing 200 $\mu$ A               | 1.6                    |         | $IOV_{DD}$ | V            |
| Low-level output voltage, $V_{OL}$ (SDO)  | $IOV_{DD} = +2.7V$ to $+5.5V$ , sinking 1mA             | 0                      |         | 0.4        | V            |
|   | $IOV_{DD} = +1.8V$ , sinking 200 $\mu$ A                | 0                      |         | 0.2        | V            |
| GPIO-n output voltage low, $V_{OL}$       | 1mA sink from $IOV_{DD}$                                |                        | 0.15    |            | V            |
| GPIO-n output voltage high, $V_{OH}$      | 10k $\Omega$ pull-up resistor to $IOV_{DD}$             | $0.99 \times IOV_{DD}$ |         |            | V            |
| High-impedance leakage current            | SDO and GPIO-n  |                        | $\pm 5$ |            | $\mu$ A      |
| High-impedance output capacitance         | SDO   |                        | 5       |            | pF           |
|   | GPIO-n  |                        | 14      |            | pF           |
| <b>POWER SUPPLY</b>                       |   |                        |         |            |              |
| $AV_{DD}$                                 |   | +9                     |         | +36        | V            |
| $DV_{DD}$                                 |   | +2.7                   |         | +5.5       | V            |
| $IOV_{DD}$ <sup>(18)</sup>                |   | +1.8                   |         | +5.5       | V            |
| $AI_{DD}$                                 | Normal operation, midscale code, output unloaded        |                        | 4.5     | 7          | mA           |
|   | Power down, output unloaded                             |                        | 35      |            | $\mu$ A      |
| $DI_{DD}$                                 | Normal operation  |                        | 70      |            | $\mu$ A      |
|   | Power down  |                        | 36      |            | $\mu$ A      |
| $IOI_{DD}$                                | Normal operation, $V_{IH} = IOV_{DD}$ , $V_{IL} = DGND$ |                        | 5       |            | $\mu$ A      |
|   | Power down, $V_{IH} = IOV_{DD}$ , $V_{IL} = DGND$       |                        | 5       |            | $\mu$ A      |
| Power dissipation                         | Normal operation  |                        | 140     | 225        | mW           |
| <b>TEMPERATURE RANGE</b>                  |   |                        |         |            |              |
| Specified performance                     |   | -40                    |         | +105       | $^{\circ}$ C |

(17) Specified by design.

(18)  $IOV_{DD} \leq DV_{DD}$ .

**FUNCTIONAL BLOCK DIAGRAM**

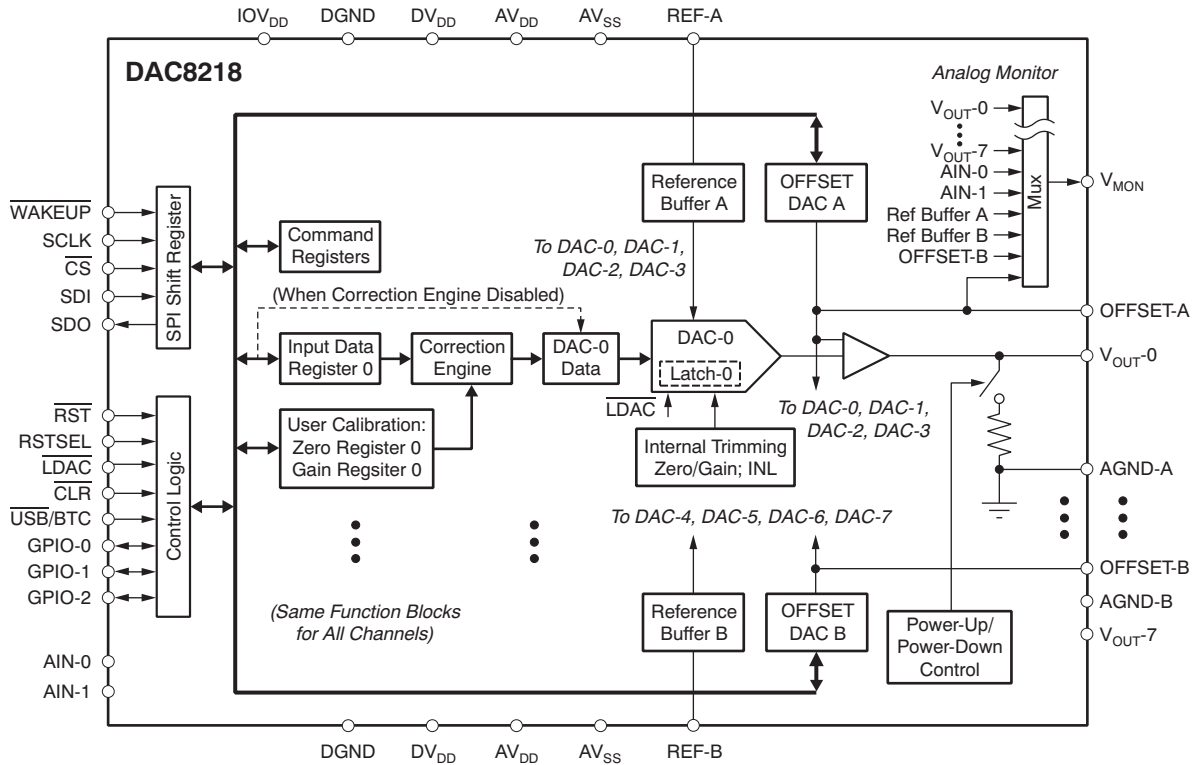

**Figure 1. Functional Block Diagram**

## PIN CONFIGURATIONS

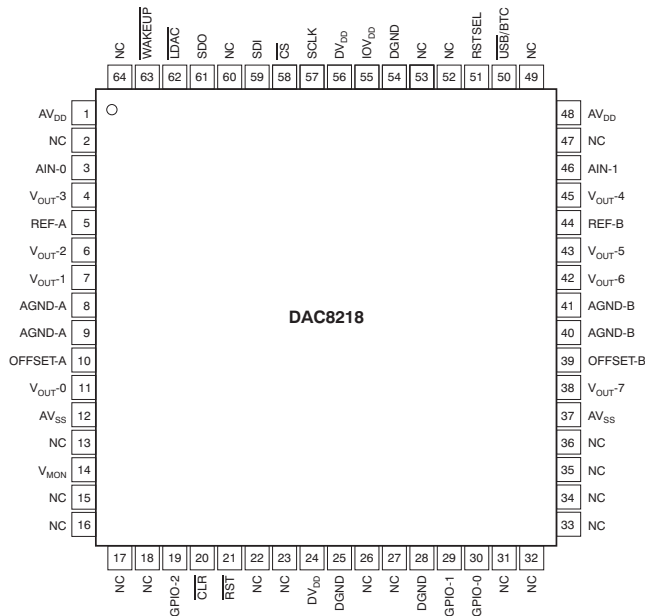
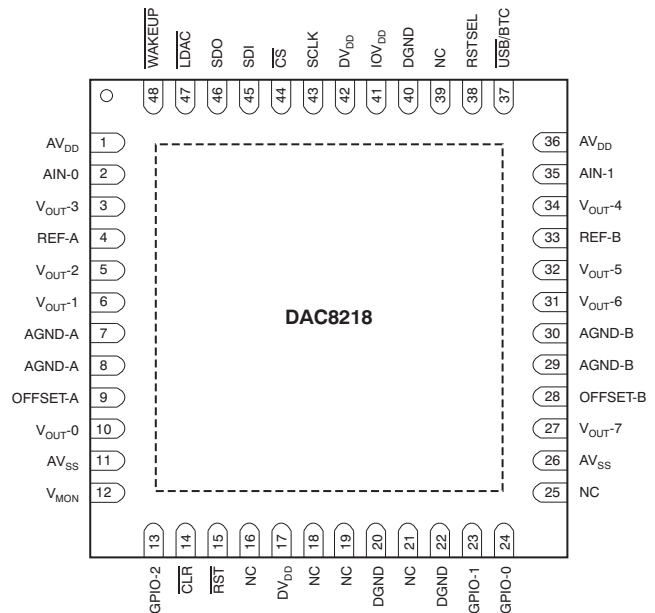
**PAG PACKAGE  
TQFP-64  
(TOP VIEW)**

**RGZ PACKAGE  
QFN-48  
(TOP VIEW)**

- (1) The thermal pad is internally connected to the substrate. This pad can be connected to AV<sub>SS</sub> or left floating. Keep the thermal pad separate from the digital ground, if possible.

## PIN DESCRIPTIONS

| PIN NAME           | PIN NO. |         | I/O | DESCRIPTION   |
|--------------------|---------|---------|-----|---|
|                    | QFN-48  | TQFP-64 |     |   |
| AV <sub>DD</sub>   | 1       | 1       | I   | Positive analog power supply  |
| AIN-0              | 2       | 3       | I   | Auxiliary analog input 0, directly routed to the analog mux   |
| V <sub>OUT-3</sub> | 3       | 4       | O   | DAC-3 output  |
| REF-A              | 4       | 5       | I   | Group A <sup>(1)</sup> reference input  |
| V <sub>OUT-2</sub> | 5       | 6       | O   | DAC-2 output  |
| V <sub>OUT-1</sub> | 6       | 7       | O   | DAC-1 output  |
| AGND-A             | 7       | 8       | I   | Group A analog ground and the ground of REF-A. This pin must be tied to AGND-B and DGND.  |
| AGND-A             | 8       | 9       | I   | Group A analog ground and the ground of REF-A. This pin must be tied to AGND-B and DGND.  |
| OFFSET-A           | 9       | 10      | O   | OFFSET DAC-A analog output. Must be connected to AGND-A during single power-supply operation (AV <sub>SS</sub> = 0V). This pin is not intended to drive an external load.   |
| V <sub>OUT-0</sub> | 10      | 11      | O   | DAC-0 output  |
| AV <sub>SS</sub>   | 11      | 12      | I   | Negative analog power supply  |
| V <sub>MON</sub>   | 12      | 14      | O   | Analog monitor output. This pin is either in Hi-Z status, connected to one of the eight DAC outputs, reference buffer outputs, offset DAC outputs, or one of the auxiliary analog inputs, depending on the content of the Monitor Register. See the Monitor Register, <a href="#">Table 12</a> , for details. |
| GPIO-2             | 13      | 19      | I/O | General-purpose digital input/output 2. This pin is a bidirectional digital input/output, open-drain and requires an external pull-up resistor. See the <a href="#">GPIO Pins</a> section for details.  |
| CLR                | 14      | 20      | I   | Clear input, level triggered. When the CLR pin is logic '0', all V <sub>OUT-X</sub> pins connect to AGND-x through switches and internal low-impedance. When the CLR pin is logic '1', all V <sub>OUT-X</sub> pins connect to the amplifier outputs.  |
| RST                | 15      | 21      | I   | Reset input (active low). Logic low on this pin resets the DAC registers and DACs to the values defined by the RSTSEL pin. CS must be logic high when RST is active.  |

(1) Group A consists of DAC-0, DAC-1, DAC-2, and DAC-3. Group B consists of DAC-4, DAC-5, DAC-6, and DAC-7.

## PIN DESCRIPTIONS (continued)

| PIN NAME                    | PIN NO.                   |  | I/O | DESCRIPTION   |
|-----------------------------|---------------------------|--|-----|---|
|                             | QFN-48                    | TQFP-64  |     |   |
| DV <sub>DD</sub>            | 17                        | 24   | I   | Digital power supply  |
| DGND                        | 20                        | 25   | I   | Digital ground  |
| DGND                        | 22                        | 28   | I   | Digital ground  |
| GPIO-1                      | 23                        | 29   | I/O | General-purpose digital input/output 1. This pin is a bidirectional digital input/output, open-drain and requires an external resistor. See the <a href="#">GPIO Pins</a> section for details.  |
| GPIO-0                      | 24                        | 30   | I/O | General-purpose digital input/output 0. This pin is a bidirectional digital input/output, open-drain and requires an external resistor. See the <a href="#">GPIO Pins</a> section for details.  |
| AV <sub>SS</sub>            | 26                        | 37   | I   | Negative analog power supply  |
| V <sub>OUT-7</sub>          | 27                        | 38   | O   | DAC-7 output  |
| OFFSET-B                    | 28                        | 39   | O   | OFFSET DAC-B analog output. Must be connected to AGND-B during single-supply operation (AV <sub>SS</sub> = 0V).   |
| AGND-B                      | 29                        | 40   | I   | Group B <sup>(1)</sup> analog ground and the ground of REF-B. This pin must be tied to AGND-A and DGND.   |
| AGND-B                      | 30                        | 41   | I   | Group B analog ground and the ground of REF-B. This pin must be tied to AGND-A and DGND.  |
| V <sub>OUT-6</sub>          | 31                        | 42   | O   | DAC-6 output  |
| V <sub>OUT-5</sub>          | 32                        | 43   | O   | DAC-5 output  |
| REF-B                       | 33                        | 44   | I   | Group B reference input   |
| V <sub>OUT-4</sub>          | 34                        | 45   | O   | DAC-4 output  |
| AIN-1                       | 35                        | 46   | I   | Auxiliary analog input 1, directly routed to the analog mux   |
| AV <sub>DD</sub>            | 36                        | 48   | I   | Positive analog power supply  |
| $\overline{\text{USB/BTC}}$ | 37                        | 50   | I   | Data format selection of Input DAC data and Offset DAC data. Data are in straight binary format when connected to DGND or in twos complement format when connected to IOV <sub>DD</sub> . The command data are always in straight binary format. Refer to <a href="#">Input Data Format</a> section for details.  |
| RSTSEL                      | 38                        | 51   | I   | Output reset selection. Selects the output voltage on the V <sub>OUT</sub> pin after power-on or hardware reset. Refer to the <a href="#">Power-On Reset</a> section for details.   |
| DGND                        | 40                        | 54   | I   | Digital ground  |
| IOV <sub>DD</sub>           | 41                        | 55   | I   | Interface power   |
| DV <sub>DD</sub>            | 42                        | 56   | I   | Digital power supply  |
| SCLK                        | 43                        | 57   | I   | SPI bus serial clock input  |
| $\overline{\text{CS}}$      | 44                        | 58   | I   | SPI bus chip select input (active low). Data are not clocked into SDI unless $\overline{\text{CS}}$ is low. When $\overline{\text{CS}}$ is high, SDO is in a high-impedance state and the SCLK and SDI signals are blocked from the device.   |
| SDI                         | 45                        | 59   | I   | SPI bus serial data input   |
| SDO                         | 46                        | 61   | O   | SPI bus serial data output.<br>When the DSDO bit = '0', the SDO pin works as an output in normal operation.<br>When the DSDO bit = '1', SDO is always in a Hi-Z state, regardless of the $\overline{\text{CS}}$ pin status. Refer to the <a href="#">Timing Diagrams</a> section for details.   |
| $\overline{\text{LDAC}}$    | 47                        | 62   | I   | Load DAC latch control input (active low). When $\overline{\text{LDAC}}$ is low, the DAC latch is transparent and the contents of the DAC Data Register are transferred to it. The DAC output changes to the corresponding level simultaneously when the DAC latch is updated. See the <a href="#">Updating the DAC Outputs</a> section for details. If asynchronous mode is desired, $\overline{\text{LDAC}}$ must be permanently tied low before power is applied to the device. If synchronous mode is desired, $\overline{\text{LDAC}}$ must be logic high during power-on. |
| $\overline{\text{WAKEUP}}$  | 48                        | 63   | I   | Wake-up input (active low). Restores the SPI from sleep to normal operation. See the <a href="#">Daisy-Chain Operation</a> section for details.   |
| NC                          | 16, 18, 19,<br>21, 25, 39 | 2, 13,<br>15-18, 22,<br>23, 26, 27,<br>31-36, 47,<br>49, 52, 53,<br>60, 64 | —   | Not connected   |

**TIMING DIAGRAMS**

Case 1: Standalone mode: Update without  $\overline{\text{LDAC}}$  pin;  $\overline{\text{LDAC}}$  pin tied to logic low.

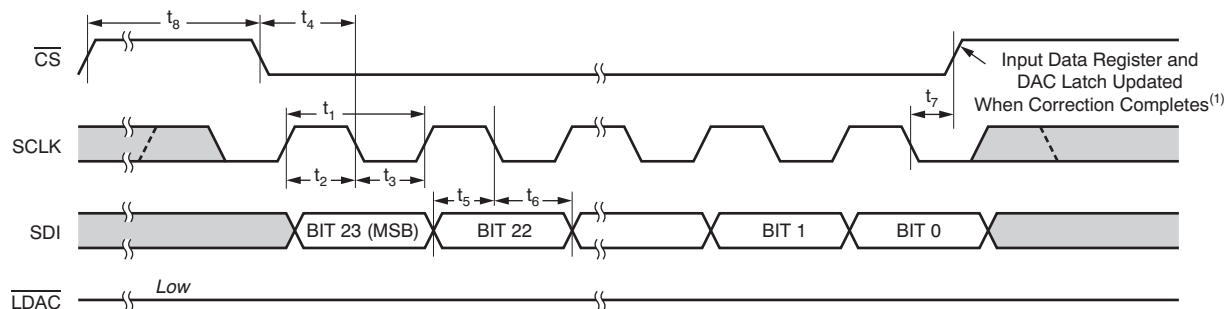

NOTE: (1) If the correction engine is off, the DAC latch is reloaded immediately after the DAC Data Register is updated.

Case 2: Standalone mode: Update with  $\overline{\text{LDAC}}$  pin.

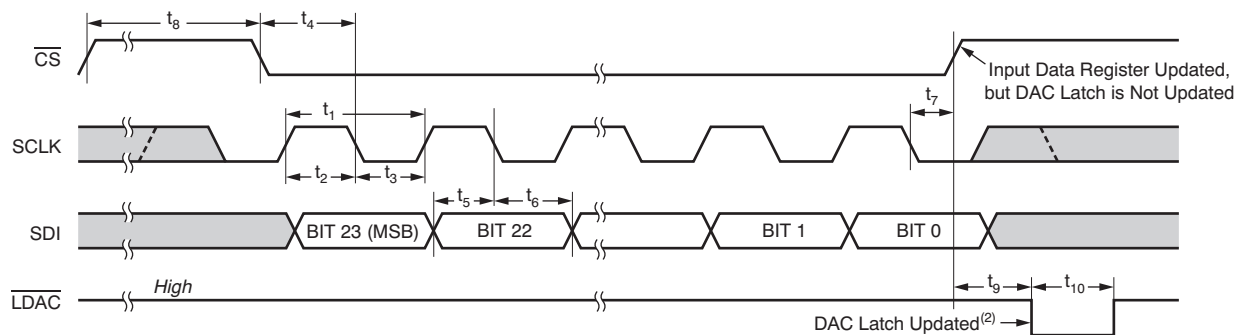

NOTE: (2) The DAC latch is updated when  $\overline{\text{LDAC}}$  goes low, as long as the timing requirement of  $t_9$  is satisfied.



**Figure 2. SPI Timing for Standalone Mode**

**TIMING DIAGRAMS (continued)**

Case 3: Daisy-Chain Mode: Update without  $\overline{\text{LDAC}}$  pin;  $\overline{\text{LDAC}}$  pin tied to logic low.

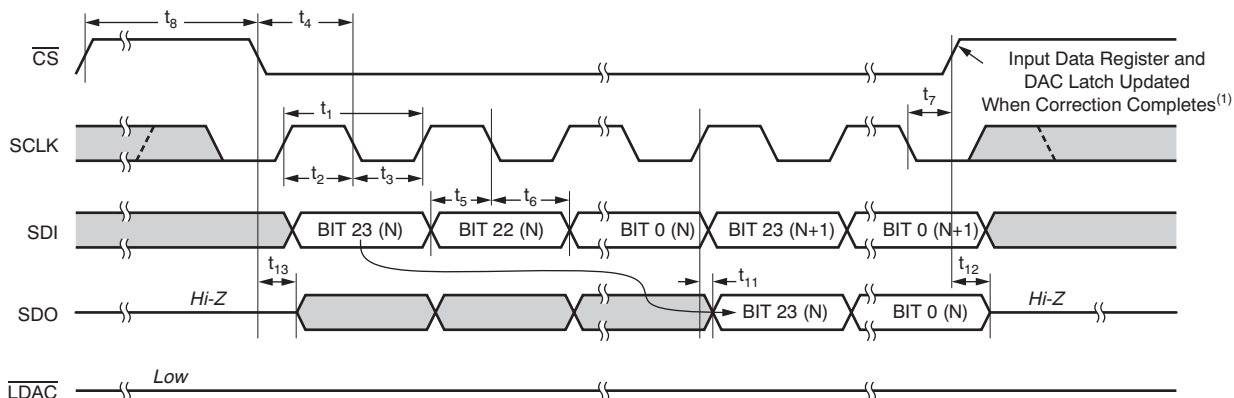

NOTE: (1) If the correction engine is off, the DAC latch is reloaded immediately after the DAC Data Register is updated.

Case 4: Daisy-Chain Mode: Update with  $\overline{\text{LDAC}}$  pin.

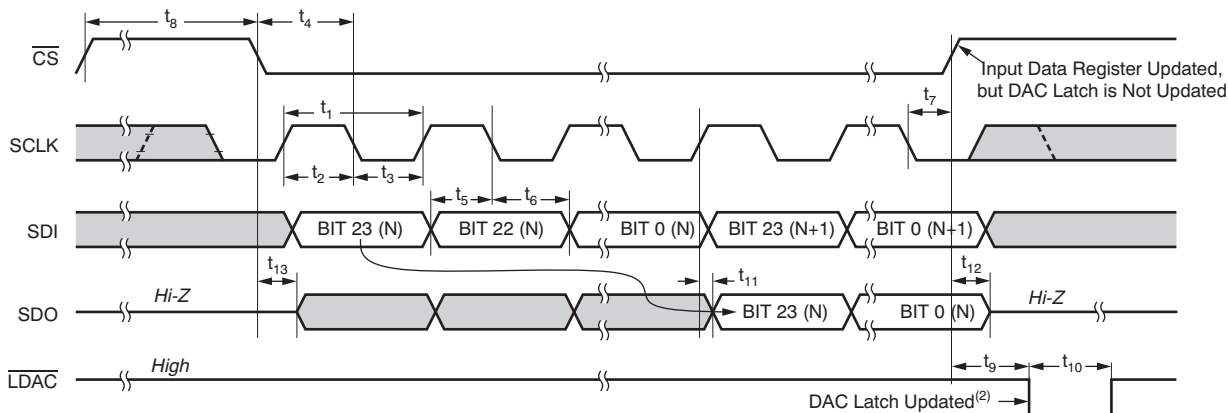

NOTE: (2) The DAC latch is updated when  $\overline{\text{LDAC}}$  goes low. The proper data are loaded if the  $t_9$  timing requirement is satisfied. Otherwise, invalid data are loaded.

Case 5: Daisy-Chain Mode: Sleeping.

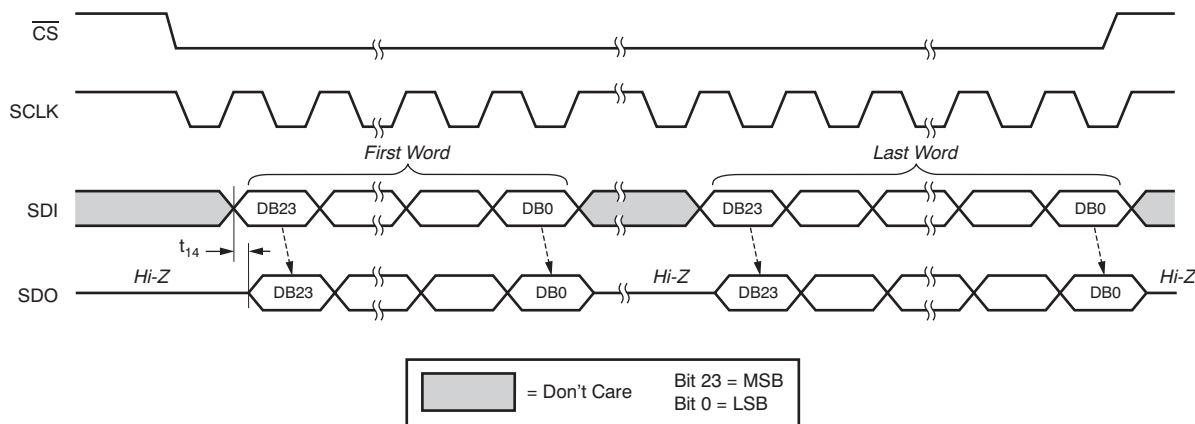

**Figure 3. SPI Timing for Daisy-Chain Mode**

**TIMING DIAGRAMS (continued)**

Case 6: Readback for Standalone mode.

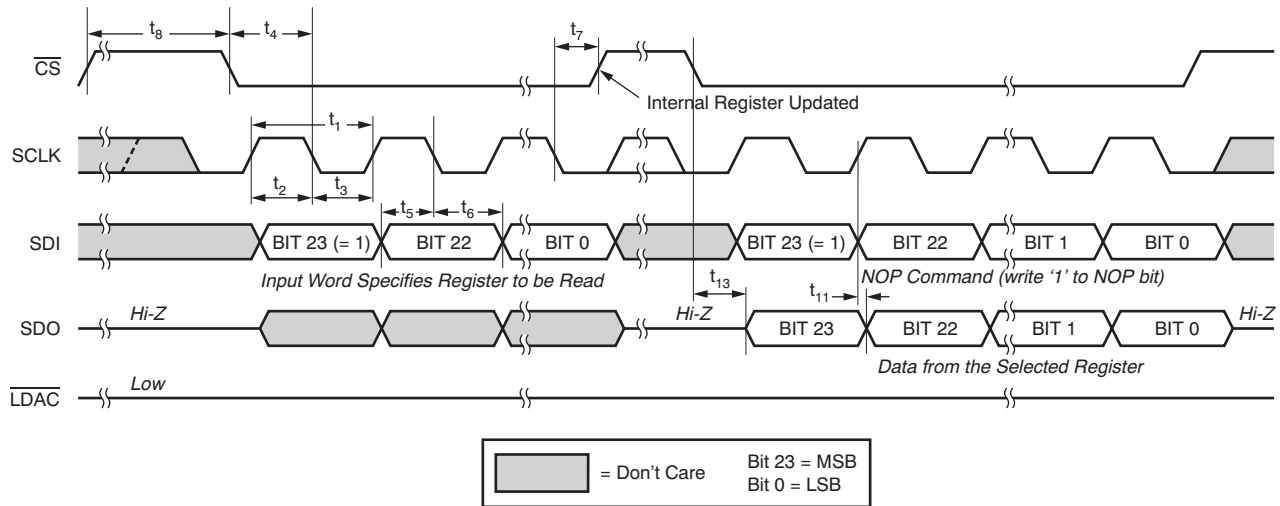

**Figure 4. SPI Timing for Readback Operation in Standalone Mode**

**TIMING CHARACTERISTICS: IOV<sub>DD</sub> = +5V<sup>(1)(2)(3)(4)</sup>**

At –40°C to +105°C, DV<sub>DD</sub> = +5V, and IOV<sub>DD</sub> = +5V, unless otherwise noted.

| PARAMETER         |   | MIN | MAX | UNIT |
|-------------------|---|-----|-----|------|
| f <sub>SCLK</sub> | Clock frequency   |     | 50  | MHz  |
| t <sub>1</sub>    | SCLK cycle time   | 20  |     | ns   |
| t <sub>2</sub>    | SCLK high time  | 10  |     | ns   |
| t <sub>3</sub>    | SCLK low time   | 7   |     | ns   |
| t <sub>4</sub>    | $\overline{\text{CS}}$ falling edge to SCLK falling edge setup time         | 8   |     | ns   |
| t <sub>5</sub>    | SDI setup time before falling edge of SCLK                                  | 5   |     | ns   |
| t <sub>6</sub>    | SDI hold time after falling edge of SCLK                                    | 5   |     | ns   |
| t <sub>7</sub>    | SCLK falling edge to $\overline{\text{CS}}$ rising edge                     | 5   |     | ns   |
| t <sub>8</sub>    | $\overline{\text{CS}}$ high time  | 10  |     | ns   |
| t <sub>9</sub>    | $\overline{\text{CS}}$ rising edge to $\overline{\text{LDAC}}$ falling edge | 5   |     | ns   |
| t <sub>10</sub>   | $\overline{\text{LDAC}}$ pulse duration                                     | 10  |     | ns   |
| t <sub>11</sub>   | Delay from SCLK rising edge to SDO valid                                    | 3   | 8   | ns   |
| t <sub>12</sub>   | Delay from $\overline{\text{CS}}$ rising edge to SDO Hi-Z                   |     | 5   | ns   |
| t <sub>13</sub>   | Delay from $\overline{\text{CS}}$ falling edge to SDO valid                 |     | 6   | ns   |
| t <sub>14</sub>   | SDI to SDO delay during sleep mode  | 2   | 5   | ns   |

- (1) Specified by design. Not production tested.
- (2) Sample tested during the initial release and after any redesign or process changes that may affect these parameters.
- (3) All input signals are specified with t<sub>R</sub> = t<sub>F</sub> = 2ns (10% to 90% of IOV<sub>DD</sub>) and timed from a voltage level of IOV<sub>DD</sub>/2.
- (4) SDO loaded with 10Ω series resistance and 10pF load capacitance for SDO timing specifications.

**TIMING CHARACTERISTICS: IOV<sub>DD</sub> = +3V<sup>(1)(2)(3)(4)</sup>**

At –40°C to +105°C, DV<sub>DD</sub> = +3V/+5V, and IOV<sub>DD</sub> = +3V, unless otherwise noted.

| PARAMETER         |   | MIN | MAX | UNIT |
|-------------------|---|-----|-----|------|
| f <sub>SCLK</sub> | Clock frequency   |     | 25  | MHz  |
| t <sub>1</sub>    | SCLK cycle time   | 40  |     | ns   |
| t <sub>2</sub>    | SCLK high time  | 19  |     | ns   |
| t <sub>3</sub>    | SCLK low time   | 7   |     | ns   |
| t <sub>4</sub>    | $\overline{\text{CS}}$ falling edge to SCLK falling edge setup time         | 15  |     | ns   |
| t <sub>5</sub>    | SDI setup time before falling edge of SCLK                                  | 5   |     | ns   |
| t <sub>6</sub>    | SDI hold time after falling edge of SCLK                                    | 5   |     | ns   |
| t <sub>7</sub>    | SCLK falling edge to $\overline{\text{CS}}$ rising edge                     | 10  |     | ns   |
| t <sub>8</sub>    | $\overline{\text{CS}}$ high time  | 19  |     | ns   |
| t <sub>9</sub>    | $\overline{\text{CS}}$ rising edge to $\overline{\text{LDAC}}$ falling edge | 5   |     | ns   |
| t <sub>10</sub>   | $\overline{\text{LDAC}}$ pulse duration                                     | 10  |     | ns   |
| t <sub>11</sub>   | Delay from SCLK rising edge to SDO valid                                    | 3   | 15  | ns   |
| t <sub>12</sub>   | Delay from $\overline{\text{CS}}$ rising edge to SDO Hi-Z                   |     | 7   | ns   |
| t <sub>13</sub>   | Delay from $\overline{\text{CS}}$ falling edge to SDO valid                 |     | 10  | ns   |
| t <sub>14</sub>   | SDI to SDO delay during sleep mode  | 2   | 10  | ns   |

- (1) Specified by design. Not production tested.
- (2) Sample tested during the initial release and after any redesign or process changes that may affect these parameters.
- (3) All input signals are specified with t<sub>R</sub> = t<sub>F</sub> = 3ns (10% to 90% of IOV<sub>DD</sub>) and timed from a voltage level of IOV<sub>DD</sub>/2.
- (4) SDO loaded with 10Ω series resistance and 10pF load capacitance for SDO timing specifications.



**TIMING CHARACTERISTICS: IOV<sub>DD</sub> = +1.8V<sup>(1)(2)(3)(4)</sup>**

 At –40°C to +105°C, DV<sub>DD</sub> = +3V/+5V, and IOV<sub>DD</sub> = +1.8V, unless otherwise noted.

| PARAMETER         |   | MIN | MAX  | UNIT |
|-------------------|---|-----|------|------|
| f <sub>SCLK</sub> | Clock frequency   |     | 16.6 | MHz  |
| t <sub>1</sub>    | SCLK cycle time   | 60  |      | ns   |
| t <sub>2</sub>    | SCLK high time  | 28  |      | ns   |
| t <sub>3</sub>    | SCLK low time   | 7   |      | ns   |
| t <sub>4</sub>    | $\overline{CS}$ falling edge to SCLK falling edge setup time  | 28  |      | ns   |
| t <sub>5</sub>    | SDI setup time before falling edge of SCLK                    | 10  |      | ns   |
| t <sub>6</sub>    | SDI hold time after falling edge of SCLK                      | 5   |      | ns   |
| t <sub>7</sub>    | SCLK falling edge to $\overline{CS}$ rising edge              | 10  |      | ns   |
| t <sub>8</sub>    | $\overline{CS}$ high time                                     | 28  |      | ns   |
| t <sub>9</sub>    | $\overline{CS}$ rising edge to $\overline{LDAC}$ falling edge | 5   |      | ns   |
| t <sub>10</sub>   | $\overline{LDAC}$ pulse duration                              | 10  |      | ns   |
| t <sub>11</sub>   | Delay from SCLK rising edge to SDO valid                      | 3   | 25   | ns   |
| t <sub>12</sub>   | Delay from $\overline{CS}$ rising edge to SDO Hi-Z            |     | 15   | ns   |
| t <sub>13</sub>   | Delay from $\overline{CS}$ falling edge to SDO valid          |     | 23   | ns   |
| t <sub>14</sub>   | SDI to SDO delay during sleep mode                            | 2   | 25   | ns   |

- (1) Specified by design. Not production tested.
- (2) Sample tested during the initial release and after any redesign or process changes that may affect these parameters.
- (3) All input signals are specified with t<sub>R</sub> = t<sub>F</sub> = 6ns (10% to 90% of IOV<sub>DD</sub>) and timed from a voltage level of IOV<sub>DD</sub>/2.
- (4) SDO loaded with 10Ω series resistance and 10pF load capacitance for SDO timing specifications.

**TYPICAL CHARACTERISTICS: Bipolar**

At  $T_A = 25^\circ\text{C}$ ,  $AV_{DD} = 16.5\text{V}$ ,  $AV_{SS} = -16.5\text{V}$ ,  $V_{REF} = IOV_{DD} = DV_{DD} = 5\text{V}$ , gain = 6, data format=USB, unless otherwise noted.

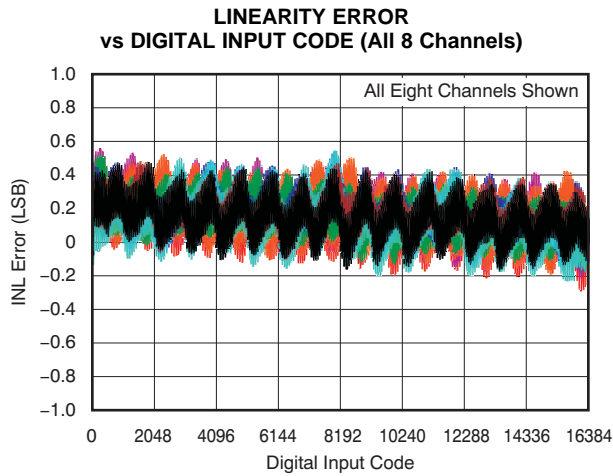

Figure 5.

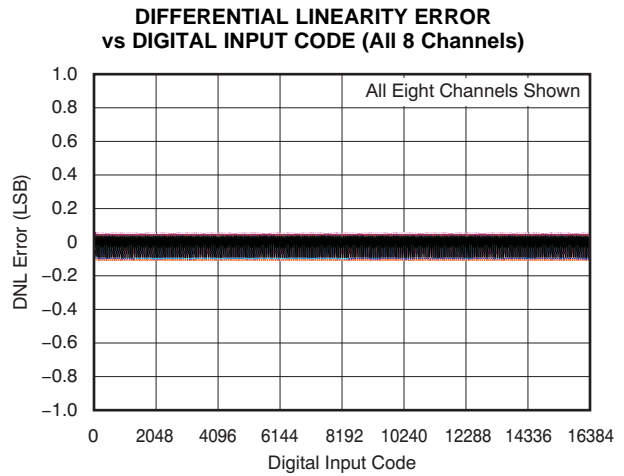

Figure 6.

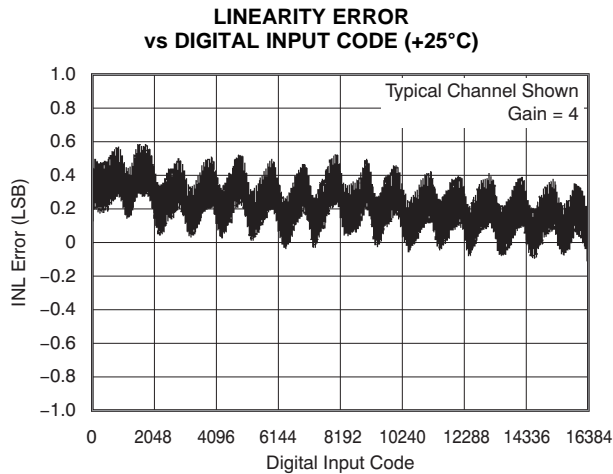

Figure 7.

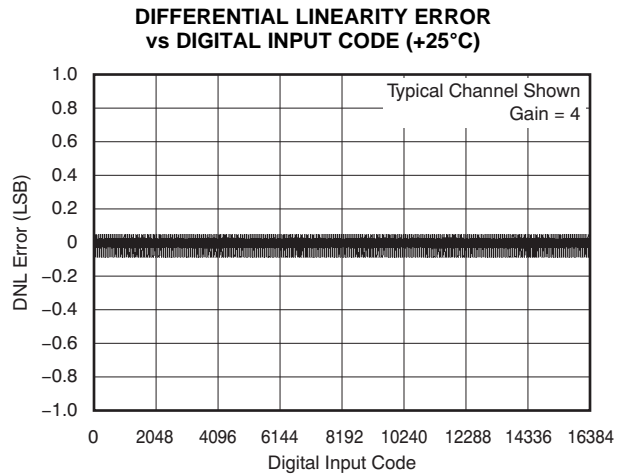

Figure 8.

**TYPICAL CHARACTERISTICS: Bipolar (continued)**

At  $T_A = 25^\circ\text{C}$ ,  $AV_{DD} = 16.5\text{V}$ ,  $AV_{SS} = -16.5\text{V}$ ,  $V_{REF} = IOV_{DD} = DV_{DD} = 5\text{V}$ , gain = 6, data format=USB, unless otherwise noted.

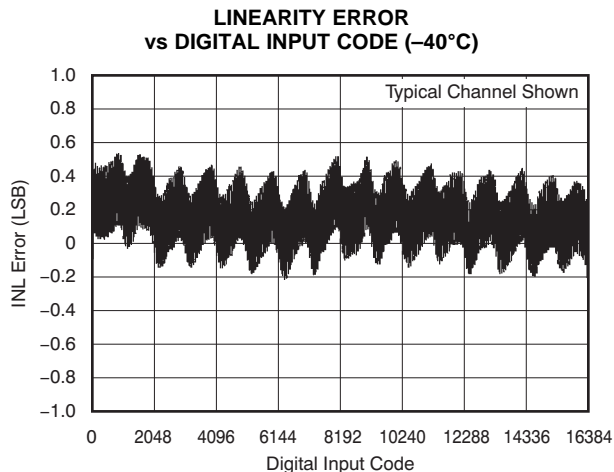

Figure 9.

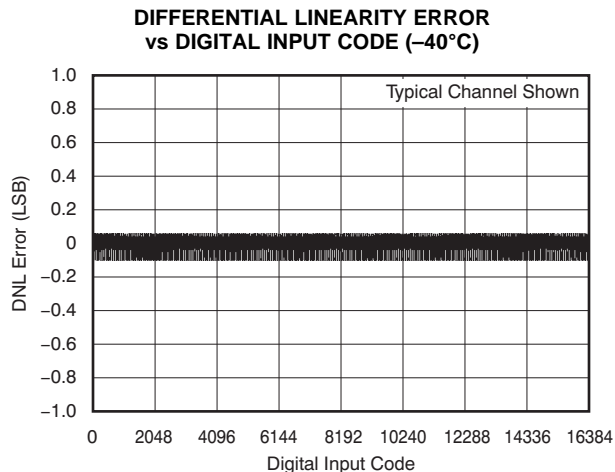

Figure 10.

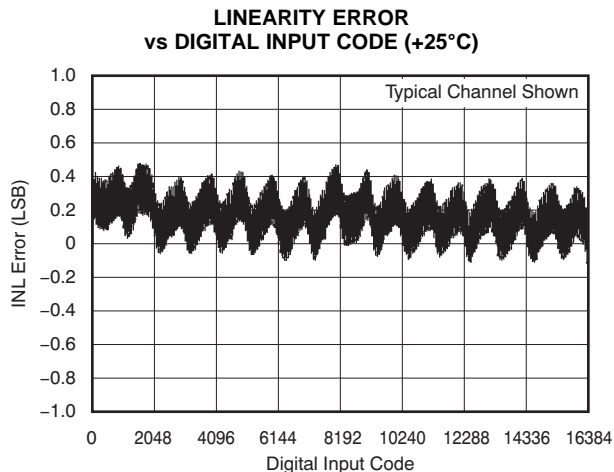

Figure 11.

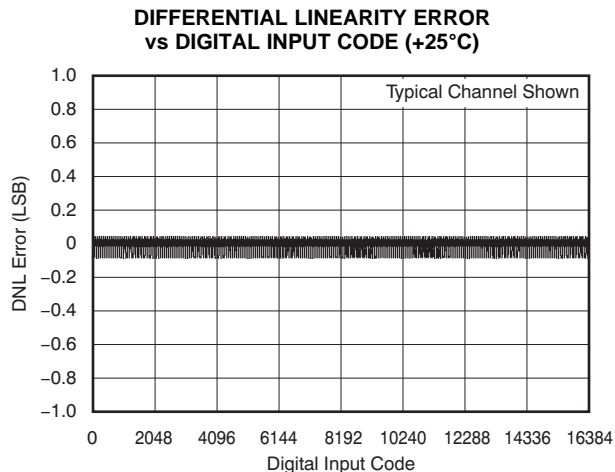

Figure 12.

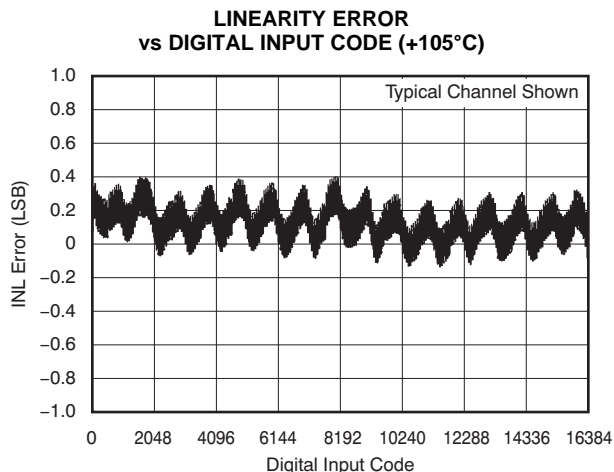

Figure 13.

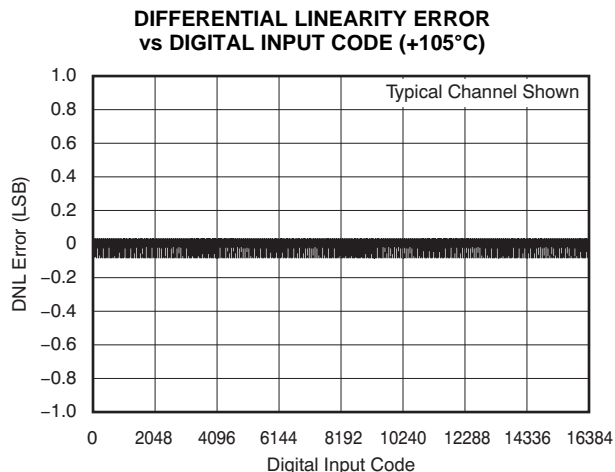

Figure 14.

**TYPICAL CHARACTERISTICS: Bipolar (continued)**

At  $T_A = 25^\circ\text{C}$ ,  $AV_{DD} = 16.5\text{V}$ ,  $AV_{SS} = -16.5\text{V}$ ,  $V_{REF} = IOV_{DD} = DV_{DD} = 5\text{V}$ , gain = 6, data format=USB, unless otherwise noted.

**LINEARITY ERROR vs TEMPERATURE**

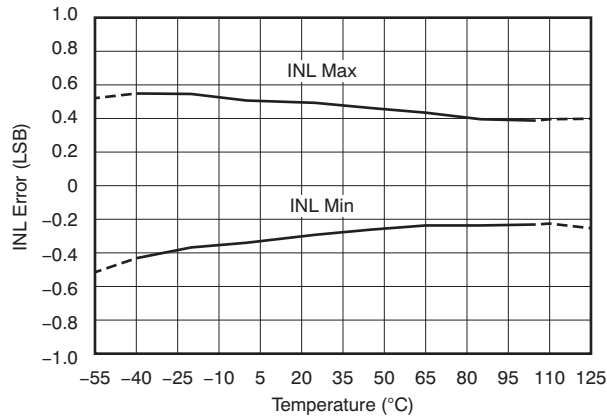

Figure 15.

**DIFFERENTIAL LINEARITY ERROR vs TEMPERATURE**

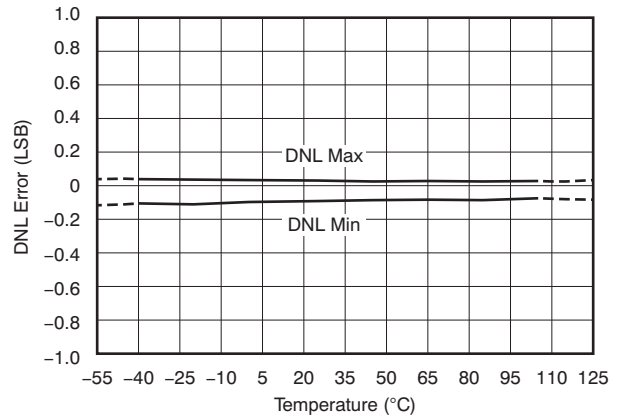

Figure 16.

**LINEARITY ERROR vs TEMPERATURE**

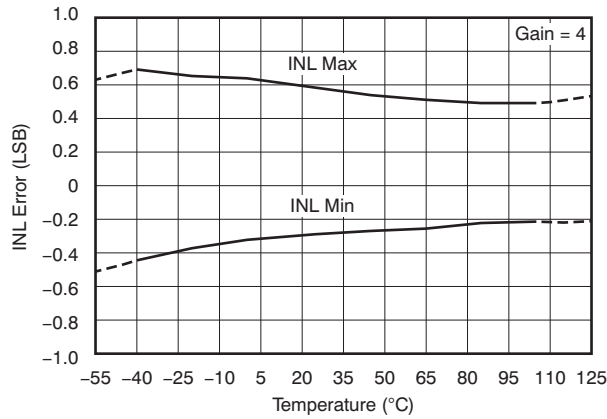

Figure 17.

**DIFFERENTIAL LINEARITY ERROR vs TEMPERATURE**

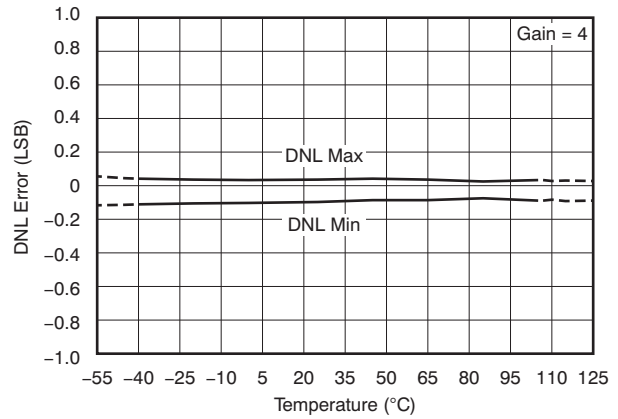

Figure 18.

**LINEARITY ERROR vs REFERENCE VOLTAGE**

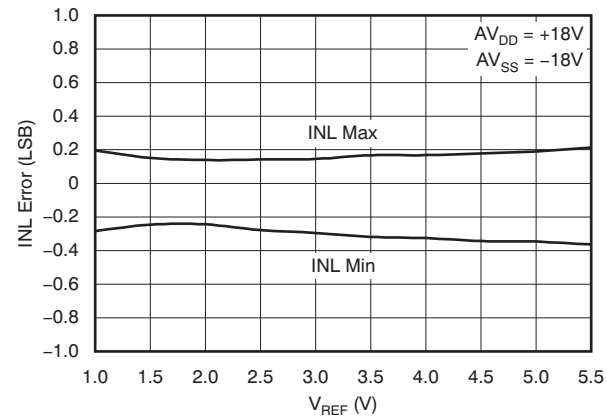

Figure 19.

**DIFFERENTIAL LINEARITY ERROR vs REFERENCE VOLTAGE**

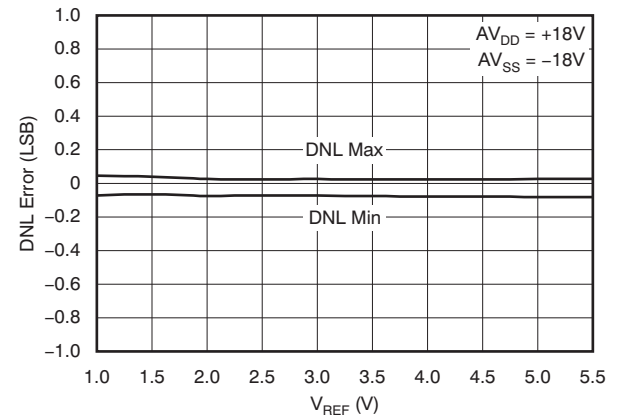

Figure 20.

**TYPICAL CHARACTERISTICS: Bipolar (continued)**

At  $T_A = 25^\circ\text{C}$ ,  $AV_{DD} = 16.5\text{V}$ ,  $AV_{SS} = -16.5\text{V}$ ,  $V_{REF} = IOV_{DD} = DV_{DD} = 5\text{V}$ , gain = 6, data format=USB, unless otherwise noted.

**LINEARITY ERROR vs  $AV_{DD}$  AND  $AV_{SS}$**

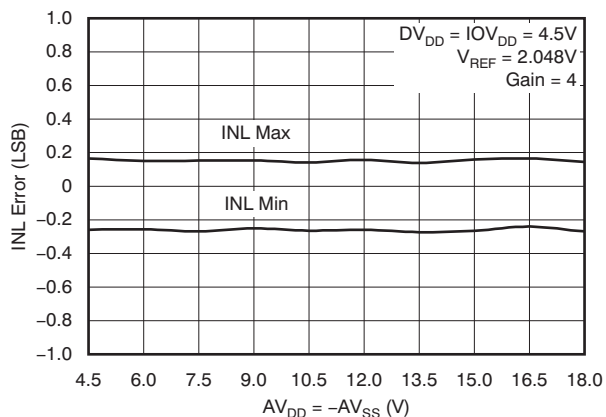

Figure 21.

**DIFFERENTIAL LINEARITY ERROR vs  $AV_{DD}$  AND  $AV_{SS}$**

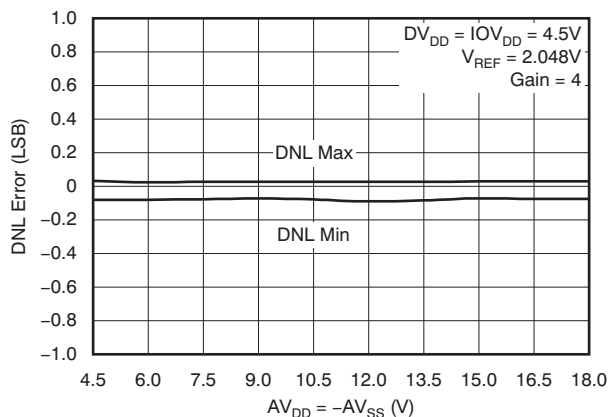

Figure 22.

**BIPOLAR ZERO ERROR vs  $AV_{DD}$  AND  $AV_{SS}$**

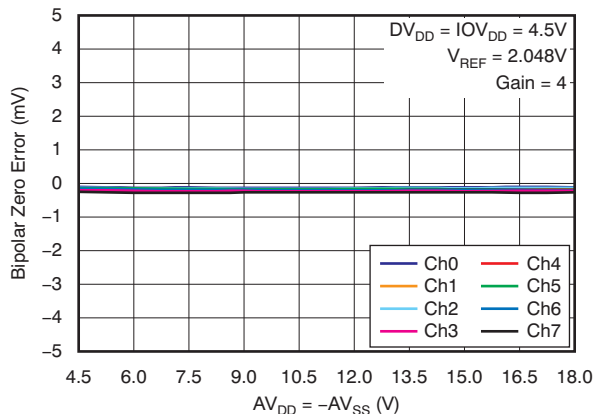

Figure 23.

**BIPOLAR GAIN ERROR vs  $AV_{DD}$  AND  $AV_{SS}$**

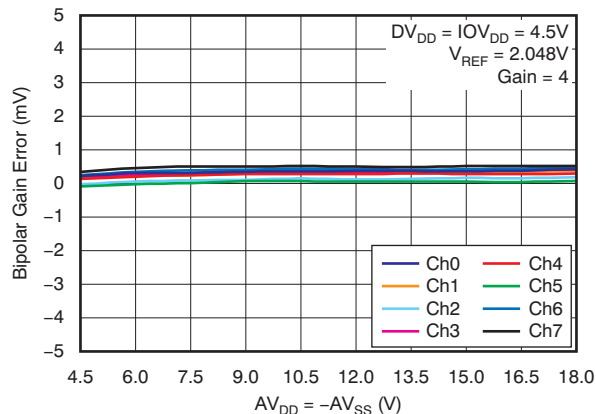

Figure 24.

**BIPOLAR ZERO ERROR vs REFERENCE VOLTAGE**

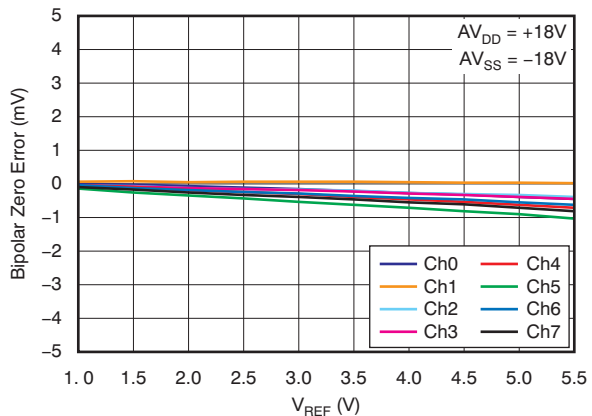

Figure 25.

**BIPOLAR GAIN ERROR vs REFERENCE VOLTAGE**

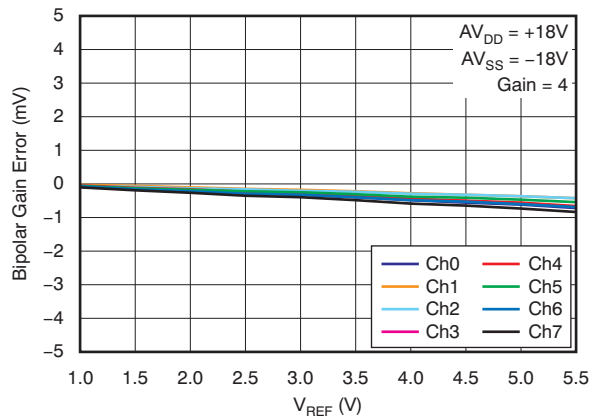

Figure 26.

**TYPICAL CHARACTERISTICS: Bipolar (continued)**

At  $T_A = 25^\circ\text{C}$ ,  $AV_{DD} = 16.5\text{V}$ ,  $AV_{SS} = -16.5\text{V}$ ,  $V_{REF} = IOV_{DD} = DV_{DD} = 5\text{V}$ , gain = 6, data format=USB, unless otherwise noted.

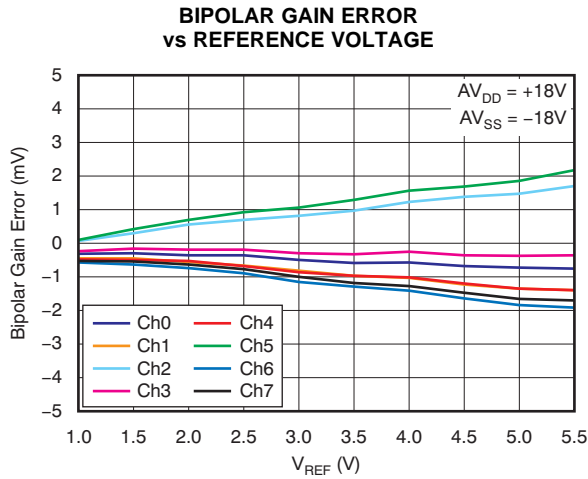

Figure 27.

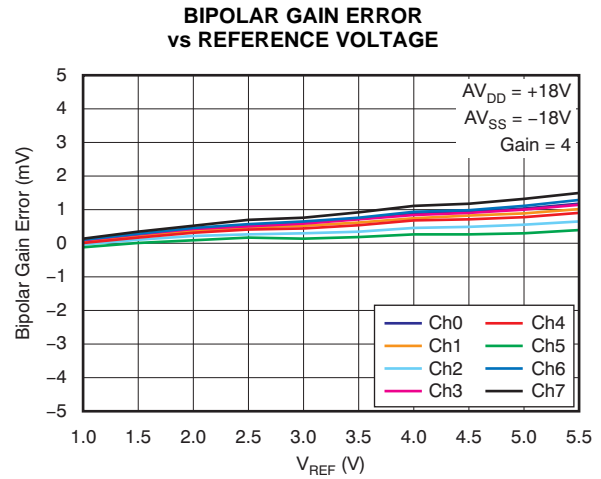

Figure 28.

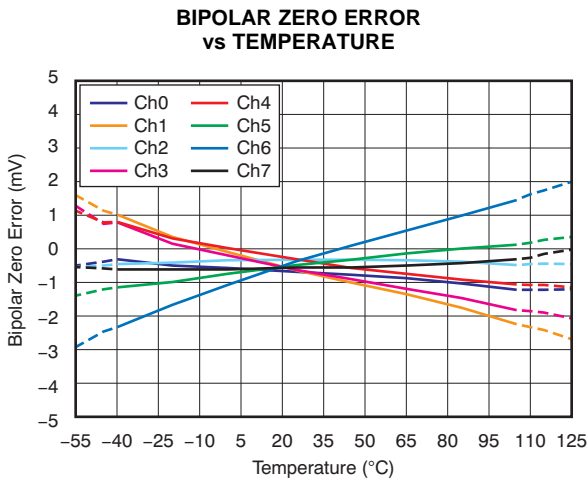

Figure 29.

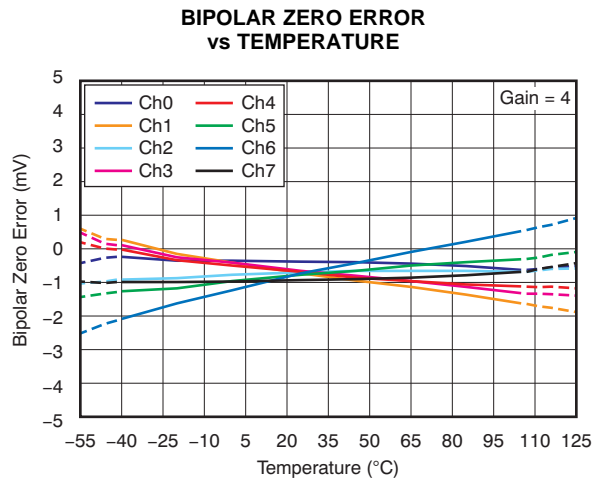

Figure 30.

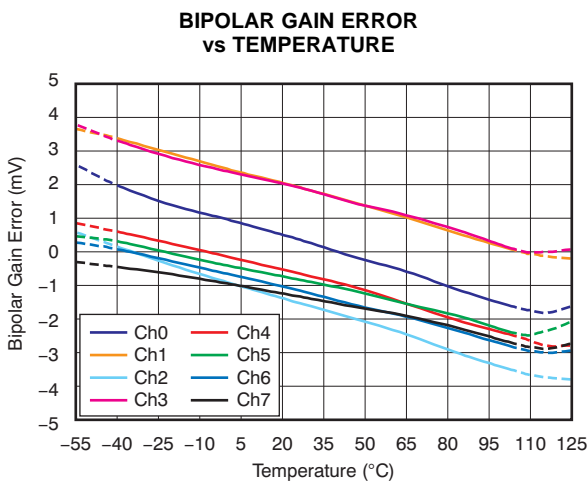

Figure 31.

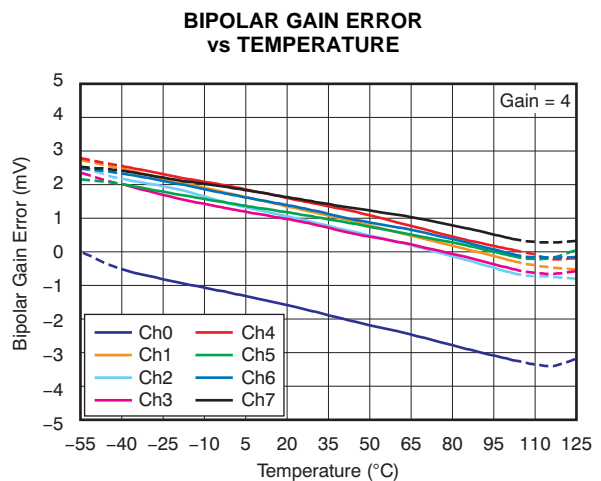

Figure 32.

**TYPICAL CHARACTERISTICS: Bipolar (continued)**

At  $T_A = 25^\circ\text{C}$ ,  $AV_{DD} = 16.5\text{V}$ ,  $AV_{SS} = -16.5\text{V}$ ,  $V_{REF} = IOV_{DD} = DV_{DD} = 5\text{V}$ , gain = 6, data format=USB, unless otherwise noted.

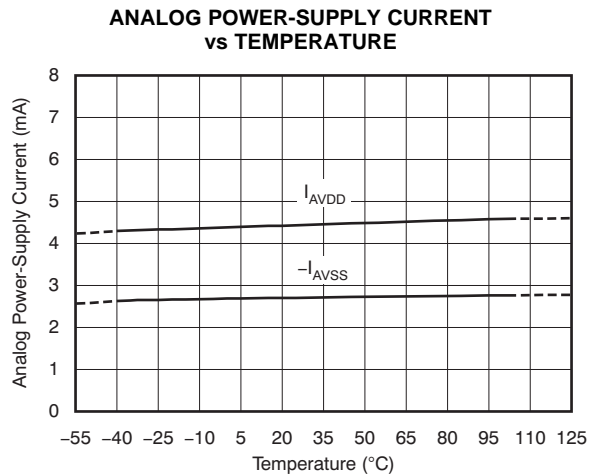

Figure 33.

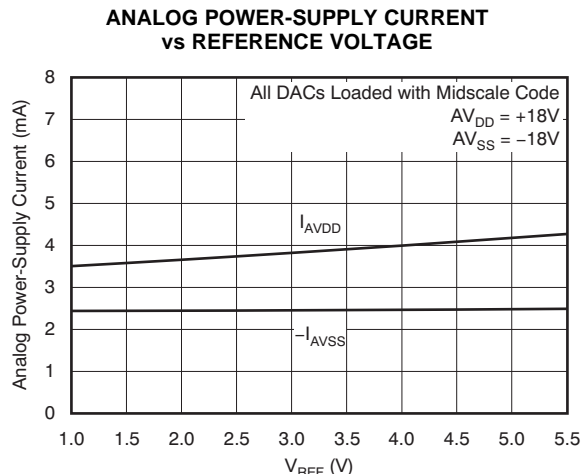

Figure 34.

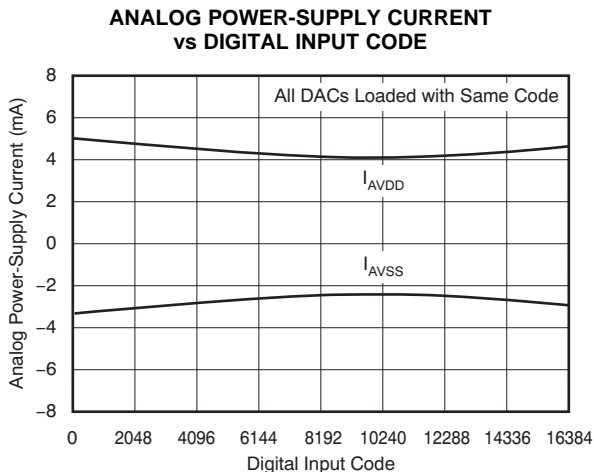

Figure 35.

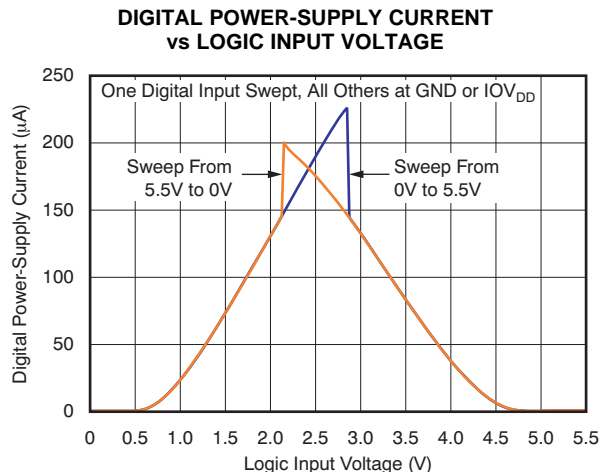

Figure 36.

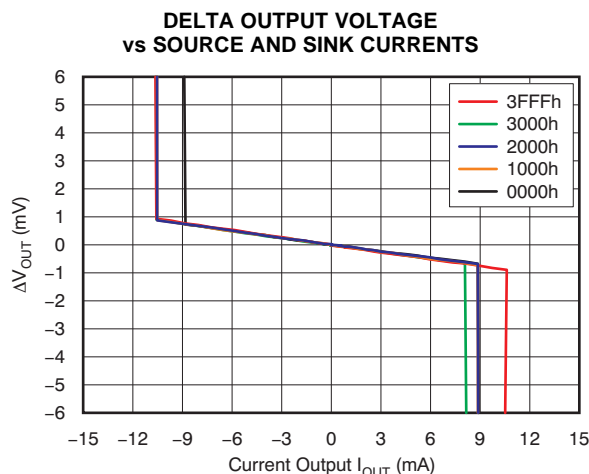

Figure 37.

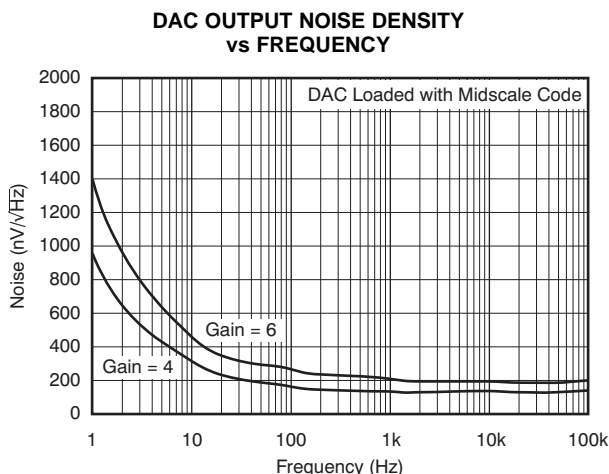
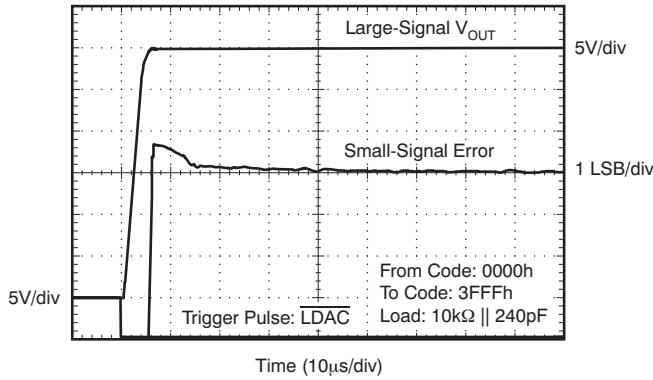

Figure 38.

**TYPICAL CHARACTERISTICS: Bipolar (continued)**

At  $T_A = 25^\circ\text{C}$ ,  $AV_{DD} = 16.5\text{V}$ ,  $AV_{SS} = -16.5\text{V}$ ,  $V_{REF} = IOV_{DD} = DV_{DD} = 5\text{V}$ , gain = 6, data format=USB, unless otherwise noted.

**SETTLING TIME  
-15V TO +15V TRANSITION**



**Figure 39.**

**SETTLING TIME  
+15V TO -15V TRANSITION**

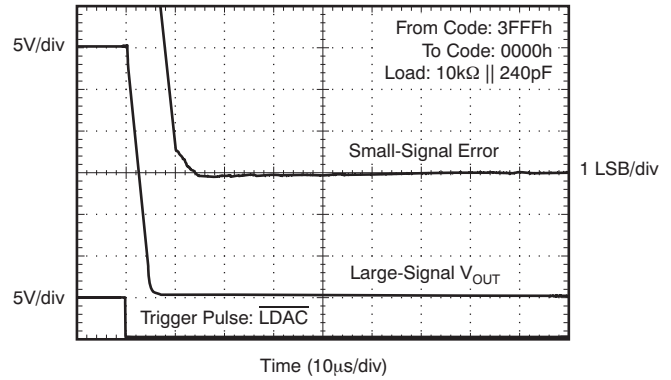

**Figure 40.**

**SETTLING TIME  
1/4 TO 3/4 FULL-SCALE TRANSITION**

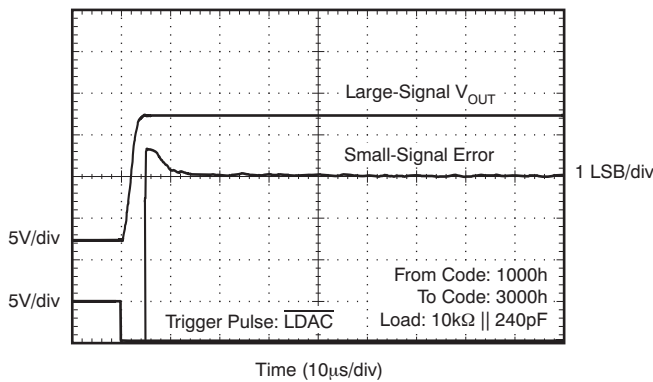

**Figure 41.**

**SETTLING TIME  
3/4 TO 1/4 FULL-SCALE TRANSITION**

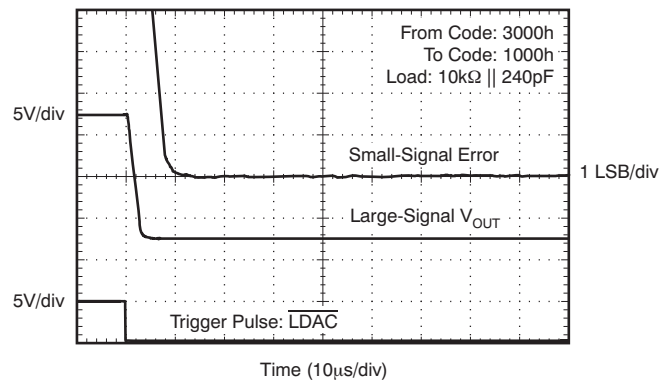

**Figure 42.**

**GLITCH ENERGY  
1 LSB STEP, RISING EDGE**

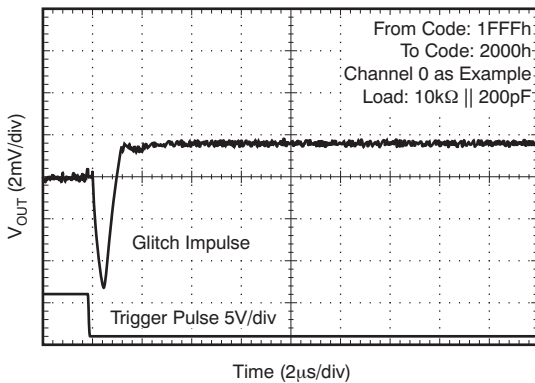

**Figure 43.**

**GLITCH ENERGY  
1 LSB STEP, FALLING EDGE**

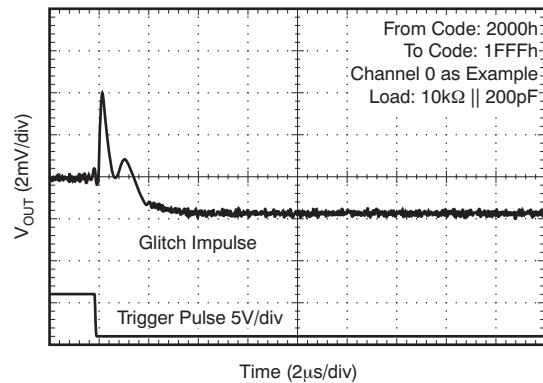

**Figure 44.**



**TYPICAL CHARACTERISTICS: Bipolar (continued)**

At  $T_A = 25^\circ\text{C}$ ,  $AV_{DD} = 16.5\text{V}$ ,  $AV_{SS} = -16.5\text{V}$ ,  $V_{REF} = IOV_{DD} = DV_{DD} = 5\text{V}$ , gain = 6, data format=USB, unless otherwise noted.

**BIPOLAR ZERO ERROR HISTOGRAM**

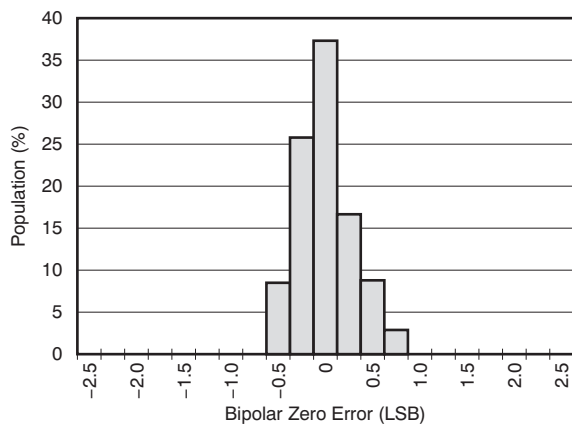

**Figure 45.**

**BIPOLAR ZERO ERROR HISTOGRAM**

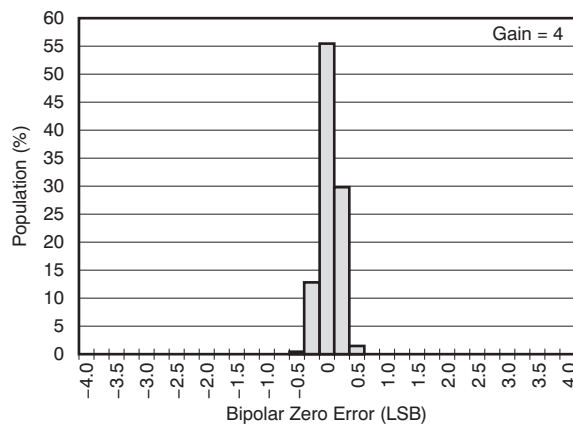

**Figure 46.**

**BIPOLAR GAIN ERROR HISTOGRAM**

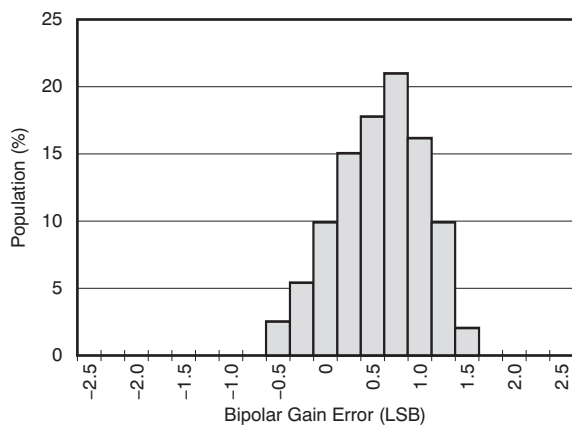

**Figure 47.**

**BIPOLAR GAIN ERROR HISTOGRAM**

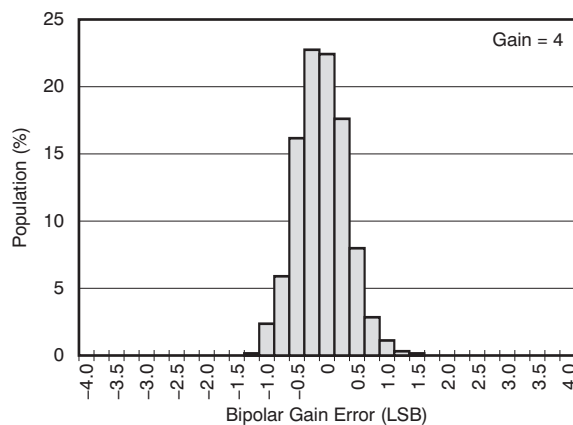

**Figure 48.**

**NEGATIVE ANALOG POWER SUPPLY HISTOGRAM**

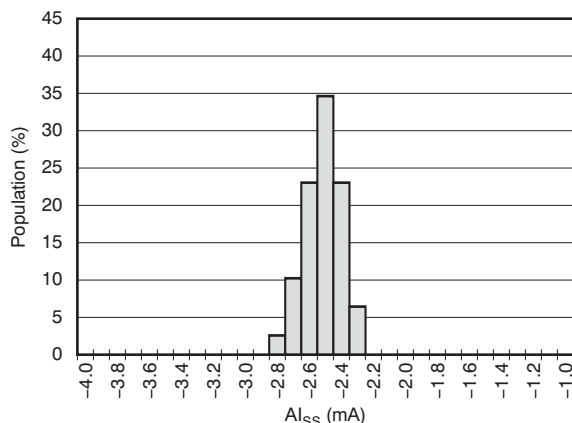

**Figure 49.**

**POSITIVE ANALOG POWER SUPPLY HISTOGRAM**

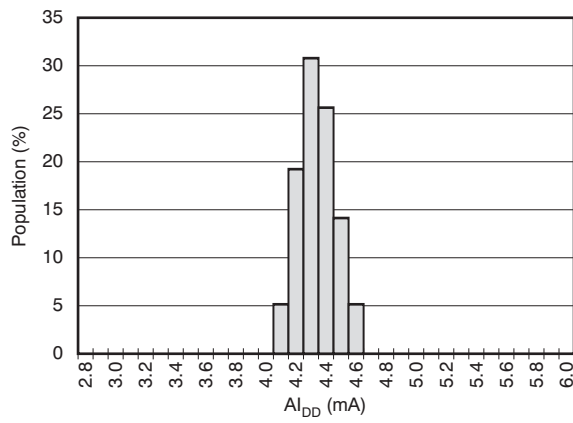
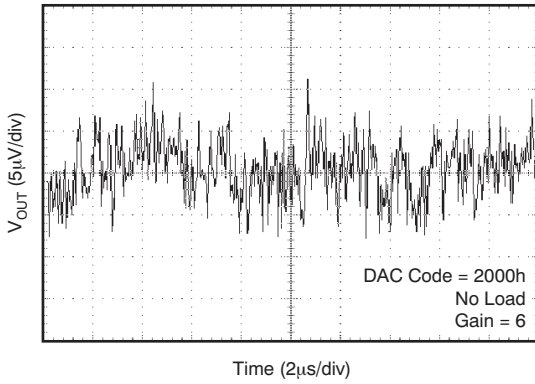

**Figure 50.**

**TYPICAL CHARACTERISTICS: Bipolar (continued)**

At  $T_A = 25^\circ\text{C}$ ,  $AV_{DD} = 16.5\text{V}$ ,  $AV_{SS} = -16.5\text{V}$ ,  $V_{REF} = IOV_{DD} = DV_{DD} = 5\text{V}$ , gain = 6, data format=USB, unless otherwise noted.

**DAC OUTPUT NOISE  
0.1Hz TO 10Hz**



**Figure 51.**

**DAC OUTPUT NOISE  
0.1Hz TO 10Hz**

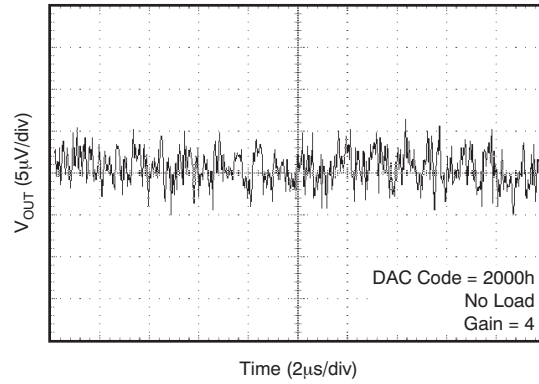

**Figure 52.**

**TYPICAL CHARACTERISTICS: Unipolar**

At  $T_A = 25^\circ\text{C}$ ,  $AV_{DD} = 32\text{V}$ ,  $AV_{SS} = 0\text{V}$ ,  $V_{REF} = 5\text{V}$ ,  $IOV_{DD} = DV_{DD} = 5\text{V}$ , gain = 6, data format=USB, unless otherwise noted.

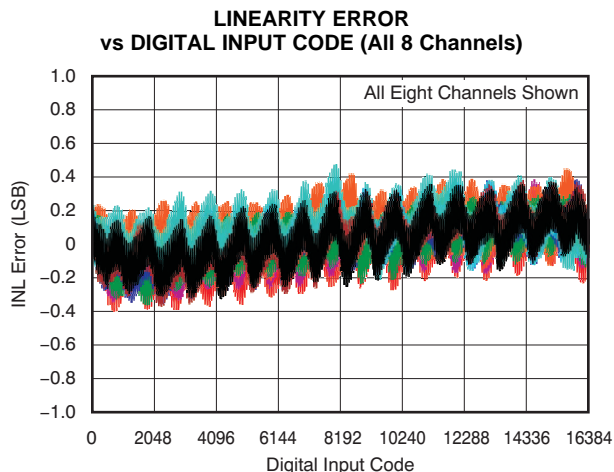

**Figure 53.**

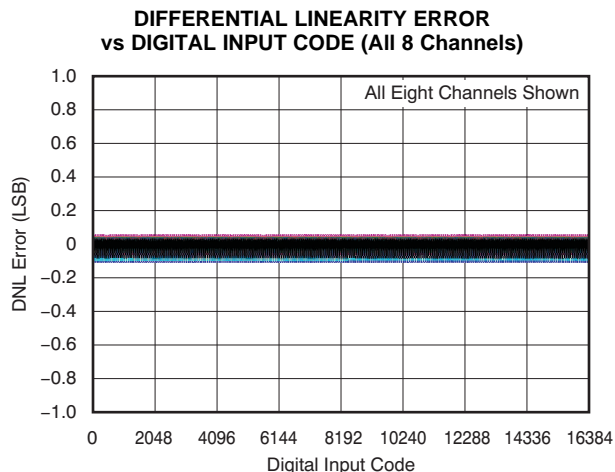

**Figure 54.**

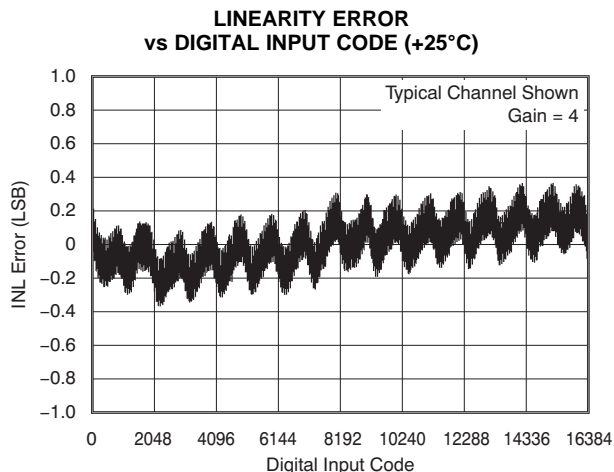

**Figure 55.**

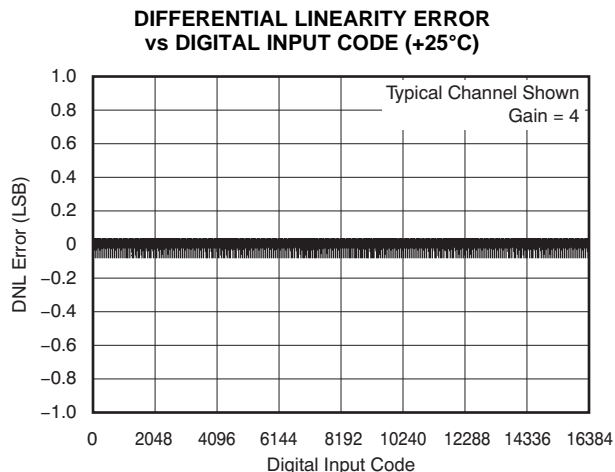

**Figure 56.**

**TYPICAL CHARACTERISTICS: Unipolar (continued)**

At  $T_A = 25^\circ\text{C}$ ,  $AV_{DD} = 32\text{V}$ ,  $AV_{SS} = 0\text{V}$ ,  $V_{REF} = 5\text{V}$ ,  $IOV_{DD} = DV_{DD} = 5\text{V}$ , gain = 6, data format=USB, unless otherwise noted.

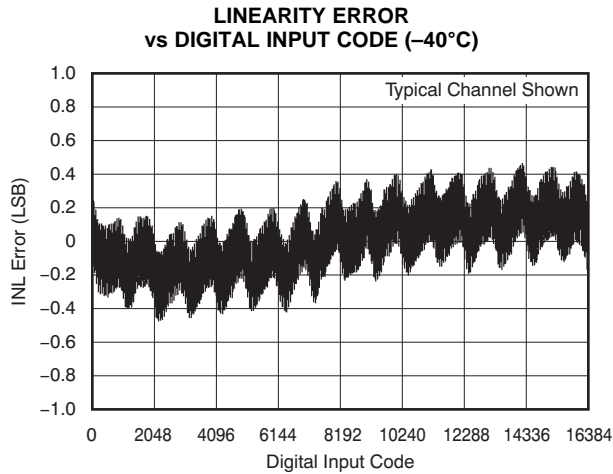

Figure 57.

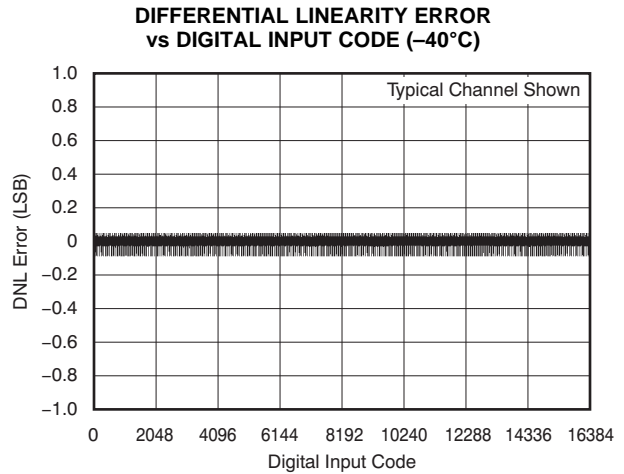

Figure 58.

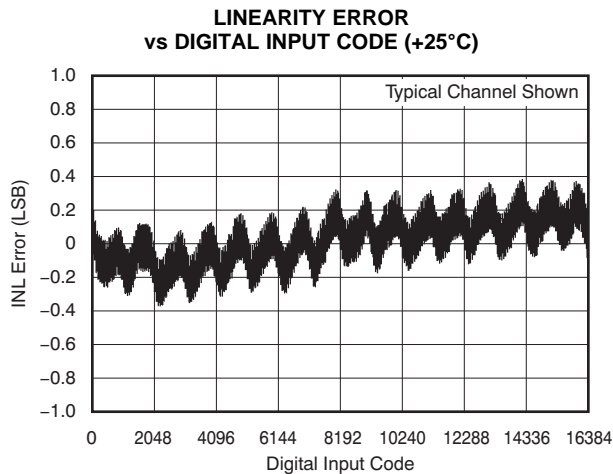

Figure 59.

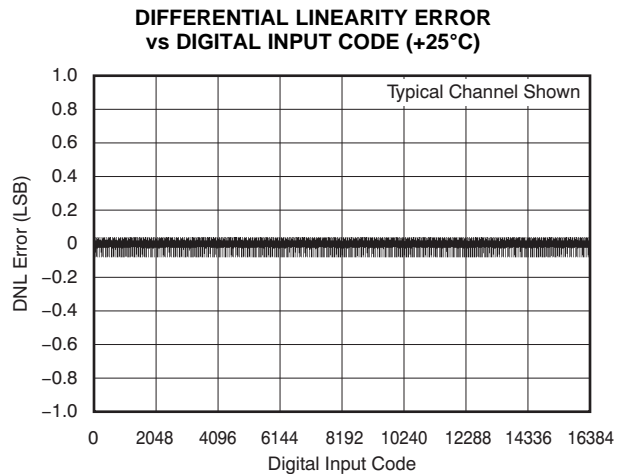

Figure 60.

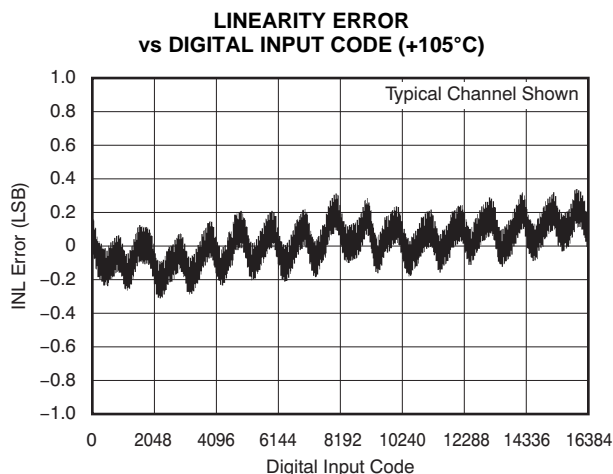

Figure 61.

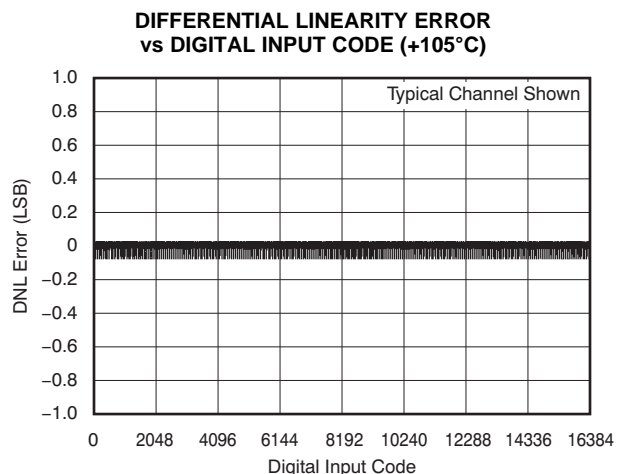
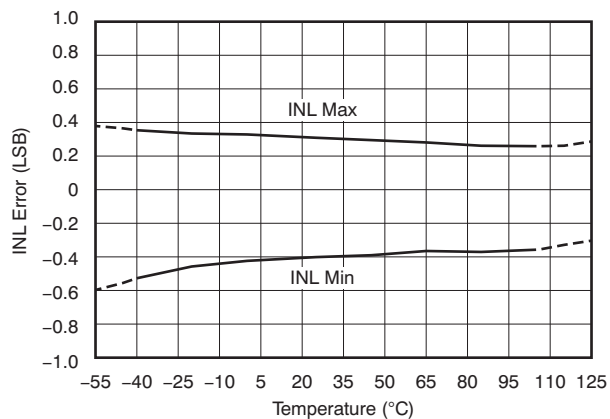

Figure 62.

**TYPICAL CHARACTERISTICS: Unipolar (continued)**

At  $T_A = 25^\circ\text{C}$ ,  $AV_{DD} = 32\text{V}$ ,  $AV_{SS} = 0\text{V}$ ,  $V_{REF} = 5\text{V}$ ,  $IOV_{DD} = DV_{DD} = 5\text{V}$ , gain = 6, data format=USB, unless otherwise noted.

**LINEARITY ERROR vs TEMPERATURE**



**Figure 63.**

**DIFFERENTIAL LINEARITY ERROR vs TEMPERATURE**

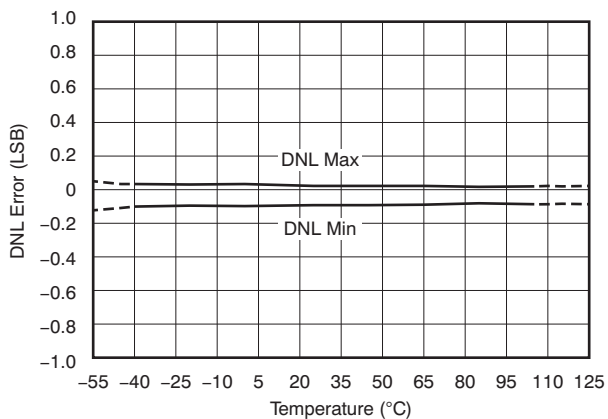

**Figure 64.**

**LINEARITY ERROR vs TEMPERATURE**

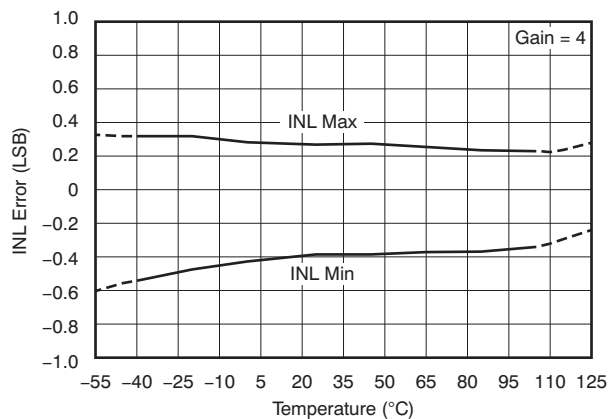

**Figure 65.**

**DIFFERENTIAL LINEARITY ERROR vs TEMPERATURE**

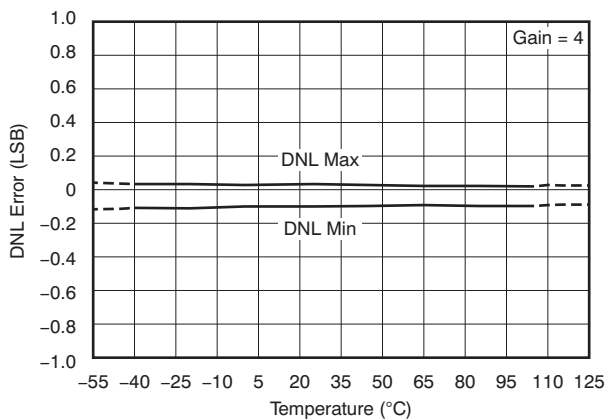

**Figure 66.**

**LINEARITY ERROR vs REFERENCE VOLTAGE**

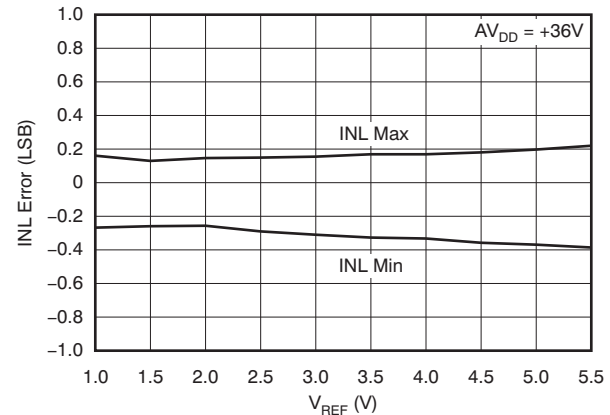

**Figure 67.**

**DIFFERENTIAL LINEARITY ERROR vs REFERENCE VOLTAGE**

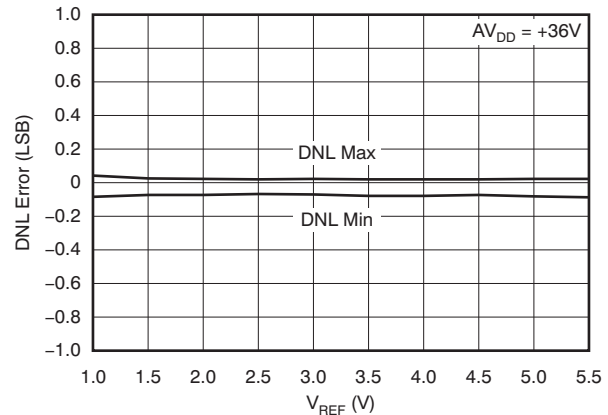

**Figure 68.**

**TYPICAL CHARACTERISTICS: Unipolar (continued)**

At  $T_A = 25^\circ\text{C}$ ,  $AV_{DD} = 32\text{V}$ ,  $AV_{SS} = 0\text{V}$ ,  $V_{REF} = 5\text{V}$ ,  $IOV_{DD} = DV_{DD} = 5\text{V}$ , gain = 6, data format=USB, unless otherwise noted.

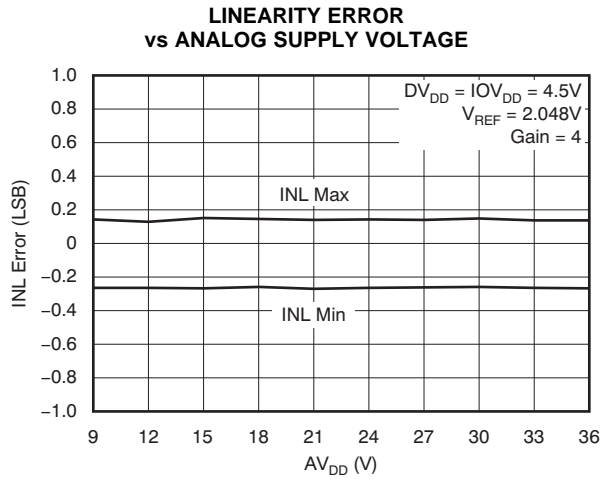

Figure 69.

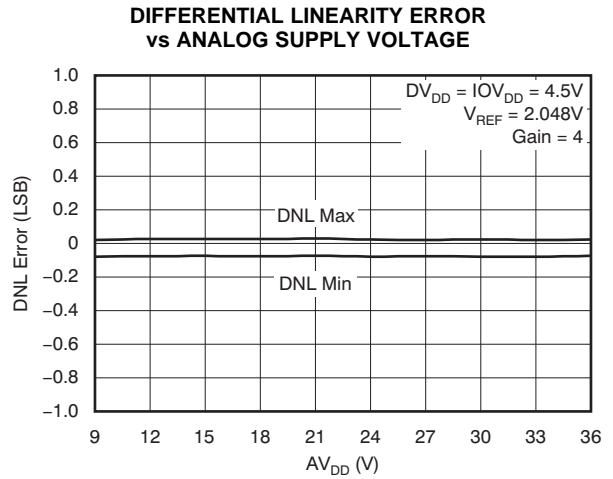

Figure 70.

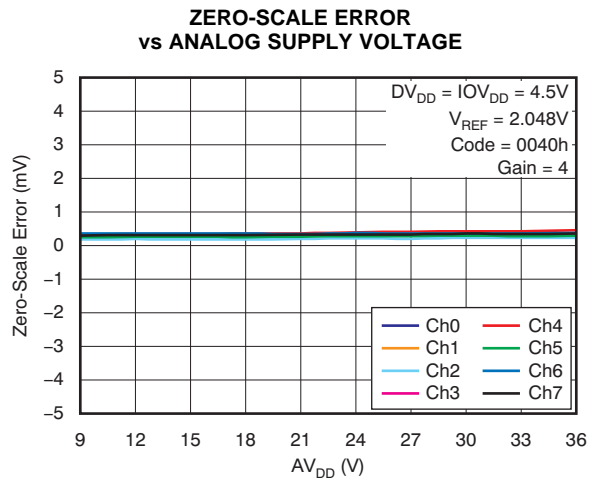

Figure 71.

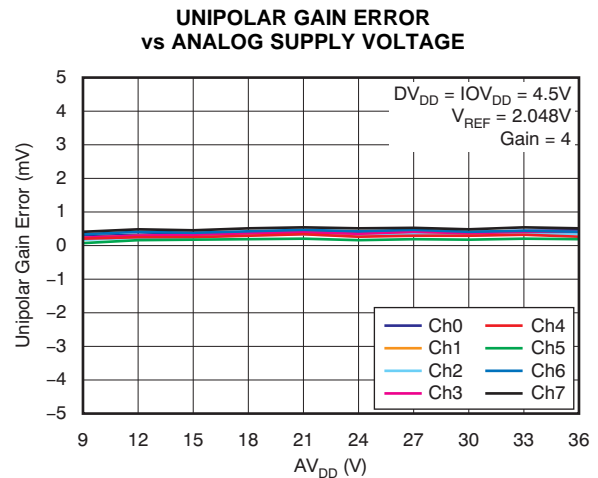

Figure 72.

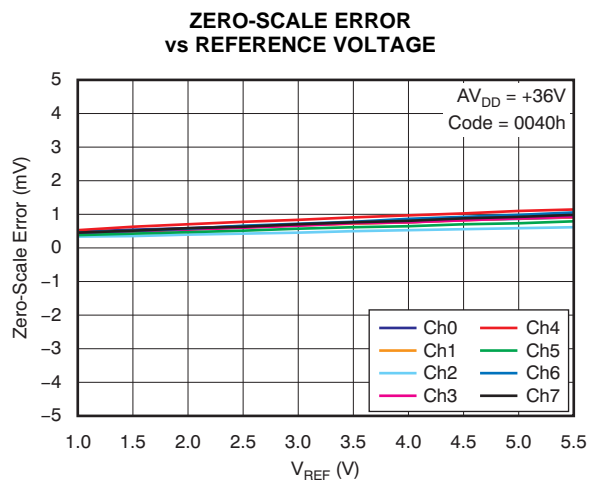

Figure 73.

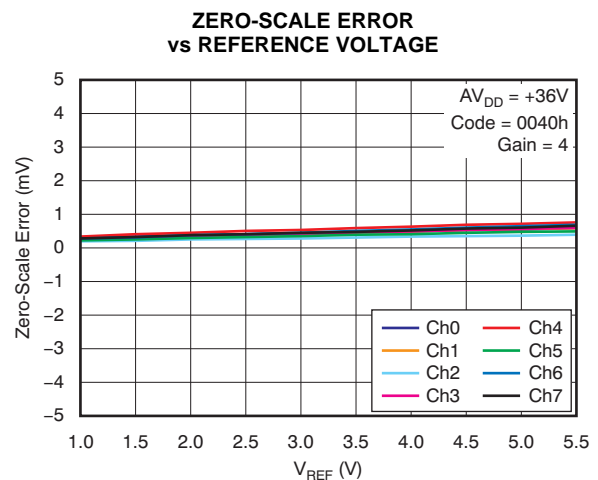

Figure 74.

**TYPICAL CHARACTERISTICS: Unipolar (continued)**

At  $T_A = 25^\circ\text{C}$ ,  $AV_{DD} = 32\text{V}$ ,  $AV_{SS} = 0\text{V}$ ,  $V_{REF} = 5\text{V}$ ,  $IOV_{DD} = DV_{DD} = 5\text{V}$ , gain = 6, data format=USB, unless otherwise noted.

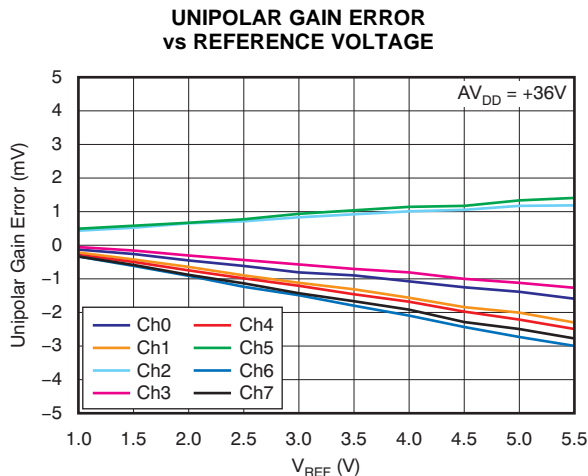

Figure 75.

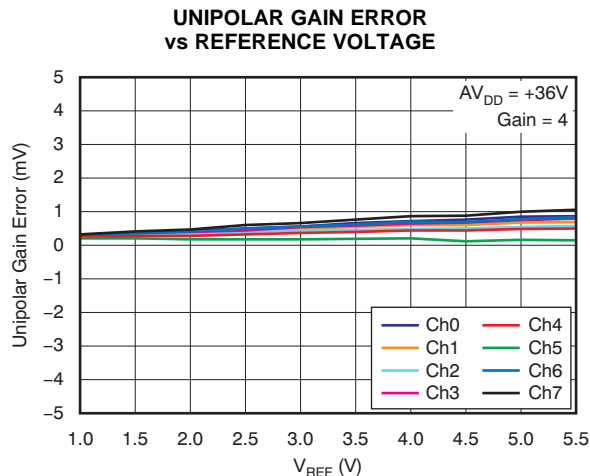

Figure 76.

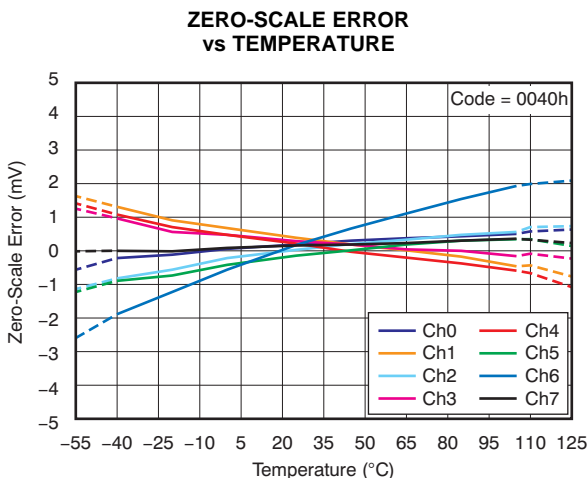

Figure 77.

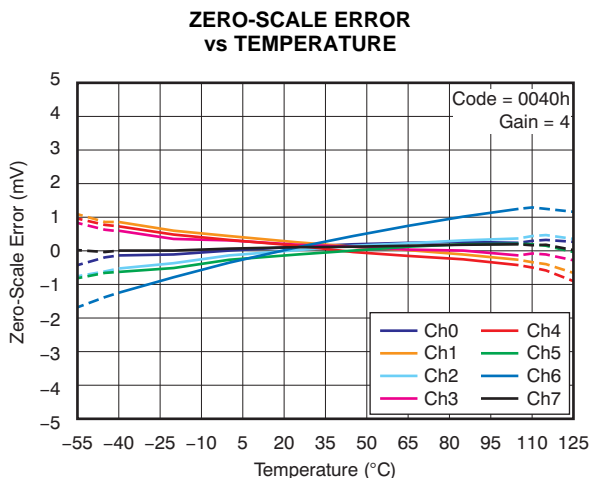

Figure 78.

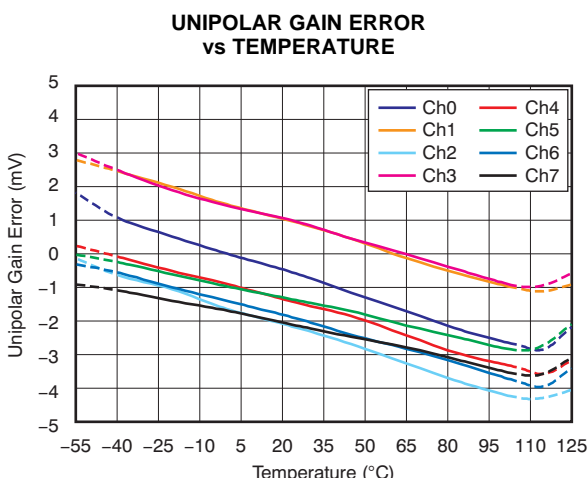

Figure 79.

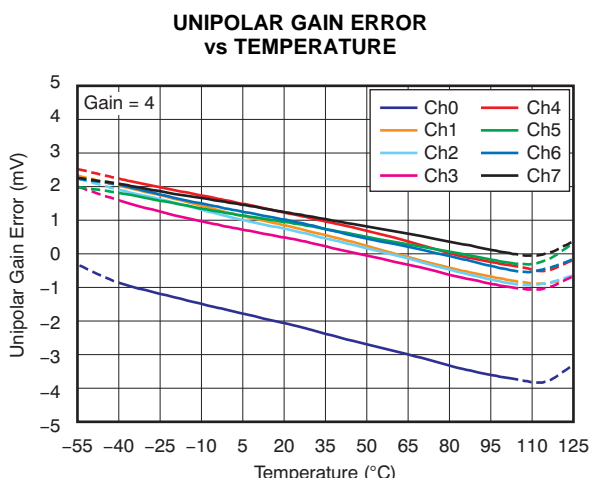

Figure 80.

**TYPICAL CHARACTERISTICS: Unipolar (continued)**

At  $T_A = 25^\circ\text{C}$ ,  $AV_{DD} = 32\text{V}$ ,  $AV_{SS} = 0\text{V}$ ,  $V_{REF} = 5\text{V}$ ,  $IOV_{DD} = DV_{DD} = 5\text{V}$ , gain = 6, data format=USB, unless otherwise noted.

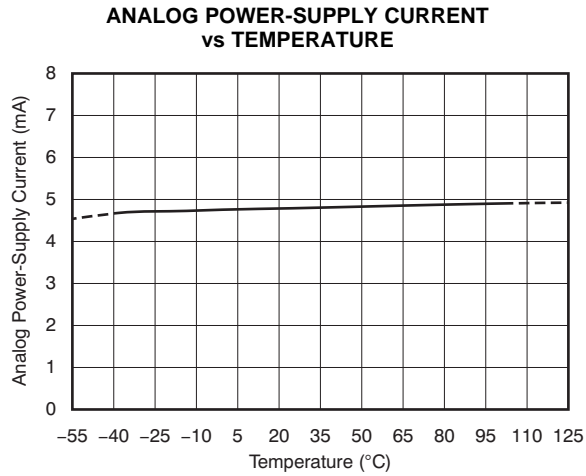

Figure 81.

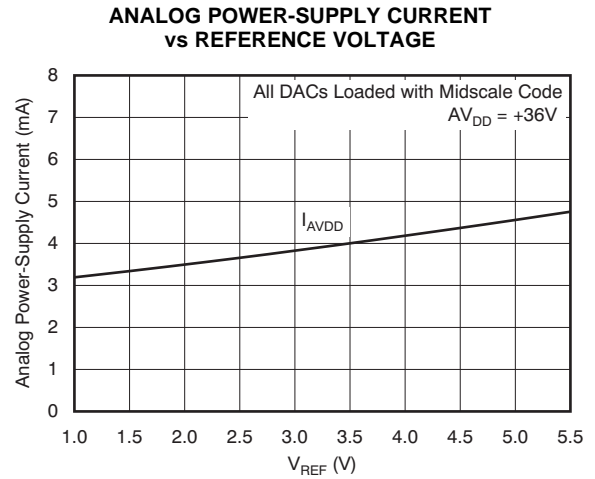

Figure 82.

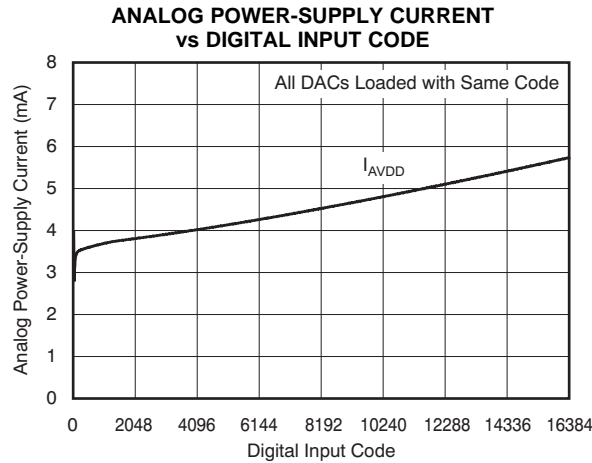

Figure 83.

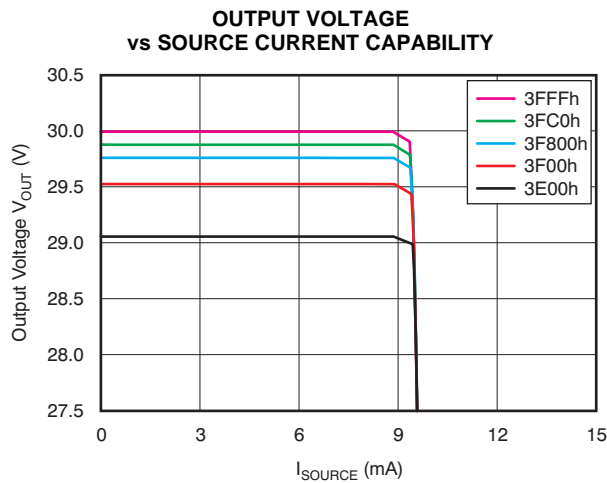

Figure 84.

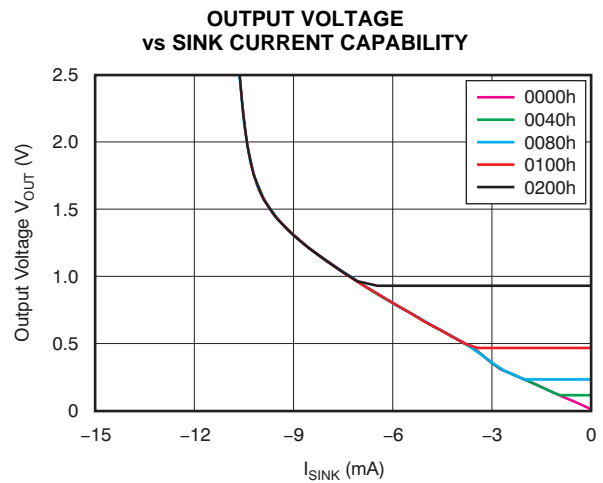

Figure 85.



**TYPICAL CHARACTERISTICS: Unipolar (continued)**

At  $T_A = 25^\circ\text{C}$ ,  $AV_{DD} = 32\text{V}$ ,  $AV_{SS} = 0\text{V}$ ,  $V_{REF} = 5\text{V}$ ,  $IOV_{DD} = DV_{DD} = 5\text{V}$ , gain = 6, data format=USB, unless otherwise noted.

**SETTLING TIME  
0V TO 30V TRANSITION**

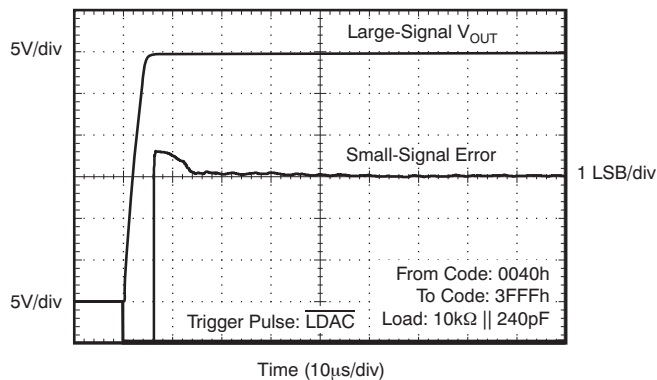

**Figure 86.**

**SETTLING TIME  
30V TO 0V TRANSITION**

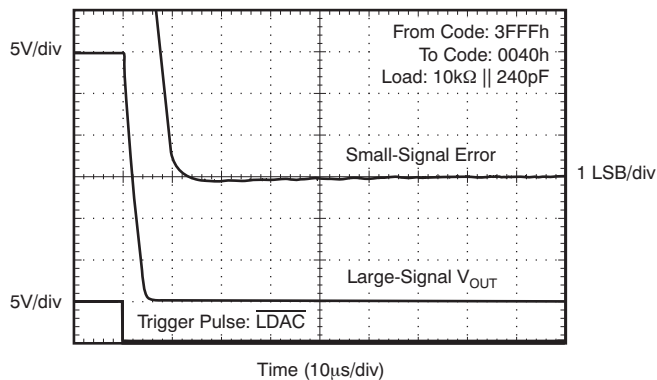

**Figure 87.**

**SETTLING TIME  
1/4 TO 3/4 TRANSITION**

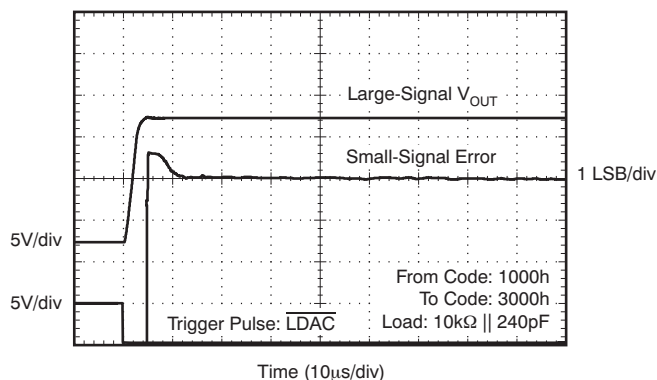

**Figure 88.**

**SETTLING TIME  
3/4 TO 1/4 TRANSITION**

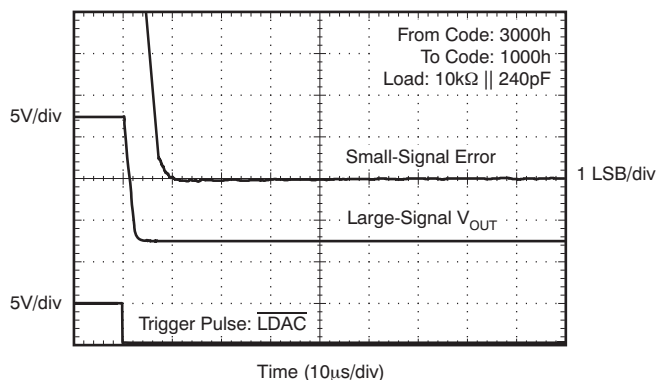

**Figure 89.**

**GLITCH ENERGY  
1 LSB STEP, RISING EDGE**

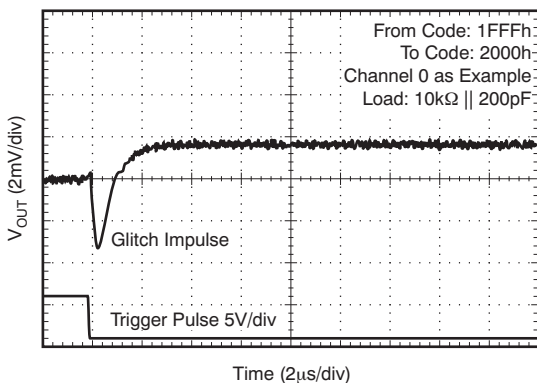

**Figure 90.**

**GLITCH ENERGY  
1 LSB STEP, FALLING EDGE**

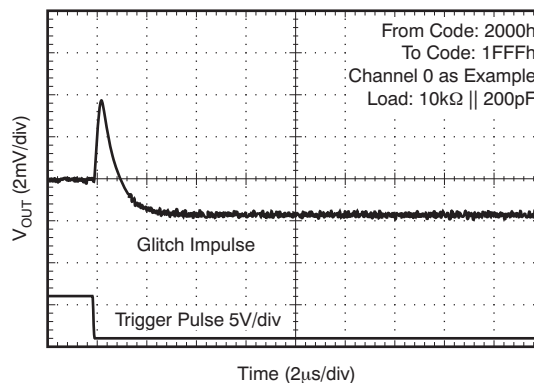
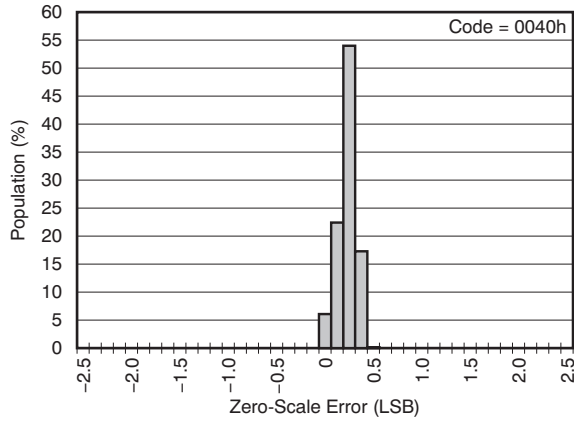

**Figure 91.**

**TYPICAL CHARACTERISTICS: Unipolar (continued)**

At  $T_A = 25^\circ\text{C}$ ,  $AV_{DD} = 32\text{V}$ ,  $AV_{SS} = 0\text{V}$ ,  $V_{REF} = 5\text{V}$ ,  $IOV_{DD} = DV_{DD} = 5\text{V}$ , gain = 6, data format=USB, unless otherwise noted.

**ZERO-SCALE ERROR HISTOGRAM**



**Figure 92.**

**ZERO-SCALE ERROR HISTOGRAM**

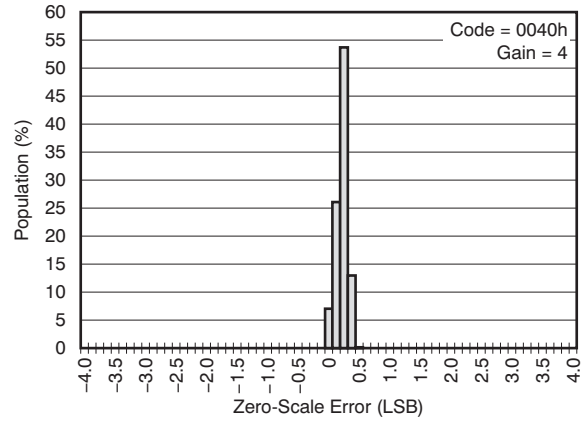

**Figure 93.**

**UNIPOLAR GAIN ERROR HISTOGRAM**

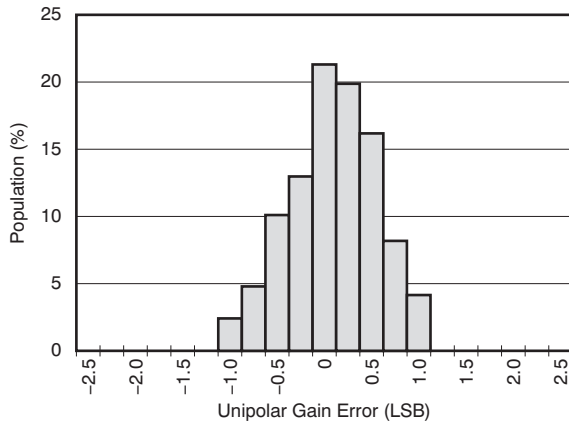

**Figure 94.**

**UNIPOLAR GAIN ERROR HISTOGRAM**

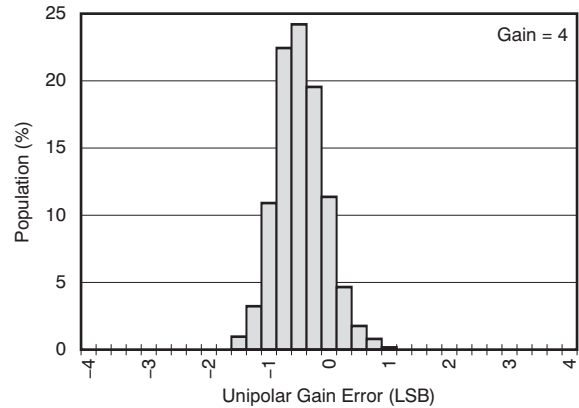

**Figure 95.**

**ANALOG POWER-SUPPLY CURRENT HISTOGRAM**

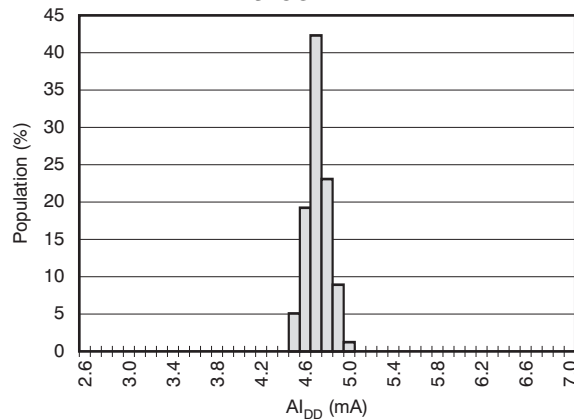
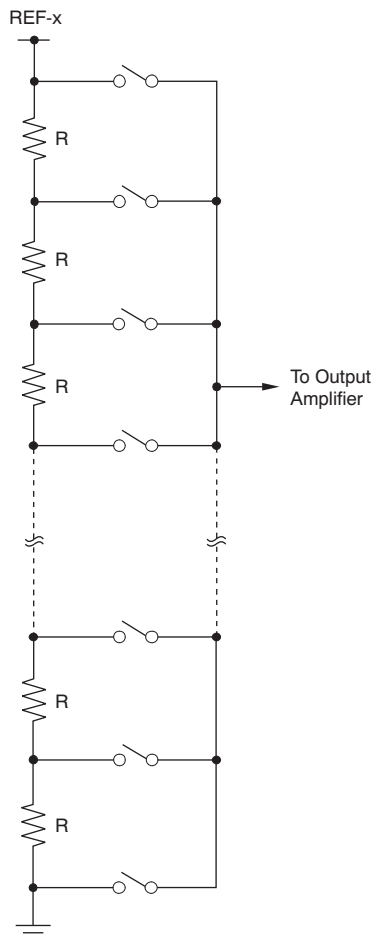

**Figure 96.**

## THEORY OF OPERATION

### GENERAL DESCRIPTION

The DAC8218 contains eight DAC channels and eight output amplifiers in a single package. Each channel consists of a resistor-string DAC followed by an output buffer amplifier. The resistor-string section is simply a string of resistors, each with a value of  $R$ , from REF-x to AGND, as shown in Figure 97. This type of architecture provides DAC monotonicity. The 14-bit binary digital code loaded to the DAC latch determines at which node on the string the voltage is tapped off before being fed into the output amplifier. The output amplifier multiplies the DAC output voltage by a gain of six or four. Using a gain of 6 and power supplies allowing for at least 0.5V headroom, the output span is 9V with a 1.5V reference, 18V with a 3V reference, and 30V with a 5V reference.



**Figure 97. Resistor String**

### CHANNEL GROUPS

The eight DAC channels and two Offset DACs are arranged into two groups (A and B) with four channels and one Offset DAC per group. Group A consists of DAC-0, DAC-1, DAC-2, DAC-3, and Offset DAC-A. Group B consists of DAC-4, DAC-5, DAC-6, DAC-7, and Offset DAC-B. Group A derives its reference voltage from REF-A, and Group B derives its reference voltage from REF-B.

## USER-CALIBRATION FOR ZERO-CODE ERROR AND GAIN ERROR

The DAC8218 implements a digital user-calibration function that allows for trimming gain and zero errors on the entire signal chain. This function can eliminate the need for external adjustment circuits. Each DAC channel has a Zero Register and Gain Register. Using the correction engine, the data from the Input Data Register are operated on by a digital adder and multiplier controlled by the contents of the Zero and Gain registers, respectively. The calibrated DAC data are then stored in the DAC Data Register where they are finally transferred into the DAC latch and set the DAC output. Each time the data are written to the Input Data Register (or to the Gain or Zero registers), the data in the Input Data Register are corrected, and the results automatically transferred to the DAC Data Register.

The range of the gain adjustment coefficient is 0.5 to 1.5. The range of the zero adjustment is  $-8192$  LSB to  $+8191$  LSB, or  $\pm 50\%$  of full scale.

There is only one correction engine in the DAC8218, which is shared among all channels.

If the user-calibration function is not needed, the correction engine can be turned off. Setting the SCE bit in the Configuration Register to '0' turns off the correction engine. Setting SCE to '1' enables the correction engine. When SCE = '0', the data are directly transferred to the DAC Data Register. In this case, writing to the Gain Register or Zero Register updates the Gain and Zero registers but does not start a math engine calculation. Reading these registers returns the written values.

**ANALOG OUTPUTS ( $V_{OUT-0}$  to  $V_{OUT-7}$ , with reference to the ground of REF-x)**

**When the correction engine is off (SCE = '0'):**

$$V_{OUT} = V_{REF} \times \text{Gain} \times \left( \frac{\text{INPUT\_CODE}}{16384} \right) - V_{REF} \times (\text{Gain} - 1) \times \left( \frac{\text{OFFSETDAC\_CODE}}{16384} \right) \quad (1)$$

**When the correction engine is on (SCE = '1'):**

$$V_{OUT} = V_{REF} \times \text{Gain} \times \left( \frac{\text{DAC\_DATA\_CODE}}{16384} \right) - V_{REF} \times (\text{Gain} - 1) \times \left( \frac{\text{OFFSETDAC\_CODE}}{16384} \right) \quad (2)$$

Where:

$$\text{DAC\_DATA\_CODE} = \left( \frac{\text{INPUT\_CODE} \times (\text{USER\_GAIN} + 2^{13})}{2^{14}} \right) + \text{USER\_ZERO}$$

*Gain* = the DAC gain defined by the GAIN bit in the Configuration Register.

*INPUT\_CODE* = data written into the Input Data Register (SCE = '1') or DAC Data Register (SCE = '0').

*OFFSETDAC\_CODE* = the data written into the Offset DAC Register.

*USER\_GAIN* = the code of the Gain Register.

*USER\_ZERO* = the code of the Zero Register.

For single-supply operation, the OFFSET-A pin must be connected to the AGND-A pin and the OFFSET-B pin must be connected to the AGND-B pin through low-impedance connections (see the [Layout](#) section for details). Offset DAC-A and Offset DAC-B are in a power-down state.

For dual-supply operation, the OFFSET-A and OFFSET-B default codes for a gain of 6 are 9830 with a  $\pm 3$  LSB variation, depending on the linearity of the Offset DACs. The default code for a gain of 4 is 10923 with a  $\pm 3$  LSB variation. The default codes of OFFSET-A and OFFSET-B are independently factory trimmed for both gains of 6 and 4.

The power-on default value of the Gain Register is 8192, and the default value of the Zero Register is '0'. The DAC input registers are set to a default value of 0000h.

Note that the maximum output voltage must not be greater than  $(AV_{DD} - 0.5V)$  and the minimum output voltage must not be less than  $(AV_{SS} + 0.5V)$ ; otherwise, the output may be saturated.

## INPUT DATA FORMAT

The  $\overline{\text{USB/BTC}}$  pin defines the input data format and the Offset DAC format. When this pin is connected to DGND, the Input DAC data and Offset DAC data are straight binary, as shown in Table 1 and Table 3. When this pin is connected to IOV<sub>DD</sub>, the Input DAC data and Offset DAC data are in twos complement format, as shown in Table 2 and Table 4.

**Table 1. Bipolar Output vs Straight Binary Code Using Dual Power Supplies with Gain = 6**

| USB CODE | NOMINAL OUTPUT                                | DESCRIPTION         |
|----------|---|---------------------|
| 3FFFh    | $+3 \times V_{\text{REF}} \times (8191/8192)$ | +Full-Scale – 1 LSB |
| ... ..   | ... ..  | ... ..              |
| 2001h    | $+3 \times V_{\text{REF}} \times (1/8192)$    | +1 LSB              |
| 2000h    | 0   | Zero                |
| 1FFFh    | $-3 \times V_{\text{REF}} \times (1/8192)$    | -1 LSB              |
| ... ..   | ... ..  | ... ..              |
| 0000h    | $-3 \times V_{\text{REF}} \times (8192/8192)$ | -Full-Scale         |

**Table 2. Bipolar Output vs Twos Complement Code Using Dual Power Supplies with Gain = 6**

| BTC CODE | NOMINAL OUTPUT                                | DESCRIPTION         |
|----------|---|---------------------|
| 1FFFh    | $+3 \times V_{\text{REF}} \times (8191/8192)$ | +Full-Scale – 1 LSB |
| ... ..   | ... ..  | ... ..              |
| 0001h    | $+3 \times V_{\text{REF}} \times (1/8192)$    | +1 LSB              |
| 0000h    | 0   | Zero                |
| 3FFFh    | $-3 \times V_{\text{REF}} \times (1/8192)$    | -1 LSB              |
| ... ..   | ... ..  | ... ..              |
| 2000h    | $-3 \times V_{\text{REF}} \times (8192/8192)$ | -Full-Scale         |

**Table 3. Unipolar Output vs Straight Binary Code Using Single Power Supply with Gain = 6**

| USB CODE | NOMINAL OUTPUT                                  | DESCRIPTION         |
|----------|---|---------------------|
| 3FFFh    | $+6 \times V_{\text{REF}} \times (16383/16384)$ | +Full-Scale – 1 LSB |
| ... ..   | ... ..  | ... ..              |
| 2001h    | $+6 \times V_{\text{REF}} \times (8193/16384)$  | Midscale + 1 LSB    |
| 2000h    | $+6 \times V_{\text{REF}} \times (8192/16384)$  | Midscale            |
| 1FFFh    | $+6 \times V_{\text{REF}} \times (8191/16384)$  | Midscale – 1 LSB    |
| ... ..   | ... ..  | ... ..              |
| 0000h    | 0   | 0                   |

**Table 4. Unipolar Output vs Twos Complement Code Using Single Power Supply with Gain = 6**

| BTC CODE | NOMINAL OUTPUT                                  | DESCRIPTION         |
|----------|---|---------------------|
| 1FFFh    | $+6 \times V_{\text{REF}} \times (16383/16384)$ | +Full-Scale – 1 LSB |
| ... ..   | ... ..  | ... ..              |
| 0001h    | $+6 \times V_{\text{REF}} \times (8193/16384)$  | Midscale + 1 LSB    |
| 0000h    | $+6 \times V_{\text{REF}} \times (8192/16384)$  | Midscale            |
| 3FFFh    | $+6 \times V_{\text{REF}} \times (8191/16384)$  | Midscale – 1 LSB    |
| ... ..   | ... ..  | ... ..              |
| 2000h    | 0   | 0                   |

The data written to the Gain Register are always in straight binary, data to the Zero Register are in twos complement, and data to all other control registers are as specified in the definitions, regardless of the  $\overline{\text{USB/BTC}}$  pin status.

In reading operation, the read-back data are in the same format as written.

## OFFSET DACS

There are two 14-bit Offset DACs: one for Group A, and one for Group B. The Offset DACs allow the entire output curve of the associated DAC groups to be shifted by introducing a programmable offset. This offset allows for asymmetric bipolar operation of the DACs or unipolar operation with bipolar supplies. Thus, subject to the limitations of headroom, it is possible to set the output range of Group A and/or Group B to be unipolar positive, unipolar negative, symmetrical bipolar, or asymmetrical bipolar, as shown in [Table 5](#) and [Table 6](#). Increasing the digital input codes for the offset DAC shifts the outputs of the associated channels in the negative direction. The default codes for the Offset DACs in the DAC8218 are factory trimmed to provide optimal offset and gain performance for the default output range and span of symmetric bipolar operation. When the output range is adjusted by changing the value of the Offset DAC, an extra offset is introduced as a result of the linearity and offset errors of the Offset DAC. Therefore, the actual shift in the output span may vary slightly from the ideal calculations. For optimal offset and gain performance in the default symmetric bipolar operation, the Offset DAC input codes should not be changed from the default power-on values. The maximum allowable offset depends on the reference and the power supply. If INPUT\_CODE from [Equation 1](#) or DAC\_DATA\_CODE from [Equation 2](#) is set to 0, then these equations simplify to [Equation 3](#):

$$V_{OUT} = -V_{REF} \times (\text{Gain} - 1) \times \left( \frac{\text{OFFSETDAC\_CODE}}{16384} \right) \quad (3)$$

This equation shows the transfer function of the Offset DAC to the output of the DAC channels. In any case, the analog output must not go beyond the specified range shown in the [Analog Outputs](#) section. After power-on or reset, the Offset DAC is set to the value defined by the selected data format and the selected analog output voltage. If the DAC gain setting is changed, the offset DAC code is reset to the default value corresponding to the new DAC gain setting. Refer to the [Power-On Reset](#) and [Hardware Reset](#) sections for details.

For single-supply operation ( $AV_{SS} = 0V$ ), the Offset DAC is turned off, and the output amplifier is in a Hi-Z state. The OFFSET-x pin must be connected to the AGND-x pin through a low-impedance connection (see the [Layout](#) section for details). For dual-supply operation, this pin provides the output of the Offset DAC. The OFFSET-x pin is not intended to drive an external load. See [Figure 98](#) for the internal Offset DAC and output amplifier configuration.

**Table 5. Example of Offset DAC Codes and Output Ranges with Gain = 6 and  $V_{REF} = 5V$**

| OFFSET DAC CODE      | OFFSET DAC VOLTAGE | DAC CHANNELS MFS <sup>(1)</sup> VOLTAGE | DAC CHANNELS PFS <sup>(1)</sup> VOLTAGE |
|----------------------|--------------------|---|---|
| 2666h <sup>(2)</sup> | 3.0V               | -15V                                    | +15V – 1 LSB                            |
| 0000h                | 0V                 | 0V                                      | +30V – 1 LSB                            |
| 3FFFh                | -5.0V              | -25V                                    | +5V – 1 LSB                             |
| 199Ah                | -2.0V              | -10V                                    | +20V – 1 LSB                            |
| 3333h                | -4.0V              | -20V                                    | +10V – 1 LSB                            |

(1) MFS = minus full-scale; PFS = plus full-scale.

(2) This is the default code for symmetric bipolar operation; actual codes may vary  $\pm 3$  LSB. Codes are in straight binary format.

**Table 6. Example of Offset DAC Codes and Output Ranges with Gain = 4 and  $V_{REF} = 5V$**

| OFFSET DAC CODE      | OFFSET DAC VOLTAGE | DAC CHANNELS MFS <sup>(1)</sup> VOLTAGE | DAC CHANNELS PFS <sup>(1)</sup> VOLTAGE |
|----------------------|--------------------|---|---|
| 2AABh <sup>(2)</sup> | ~3.33333V          | -10V                                    | +10V – 1 LSB                            |
| 0000h                | 0V                 | 0V                                      | +20V – 1 LSB                            |
| 3FFFh                | -5.0V              | -15V                                    | +5V – 1 LSB                             |
| 1555h                | ~1.666V            | -5V                                     | +15V – 1 LSB                            |
| 2000h                | 2.5V               | -7.5V                                   | +12.5V – 1 LSB                          |
| 3555h                | ~4.1666V           | -12.5V                                  | +7.5V – 1 LSB                           |

(1) MFS = minus full-scale; PFS = plus full-scale.

(2) This is the default code for symmetric bipolar operation; actual codes may vary  $\pm 3$  LSB. Codes are in straight binary format.

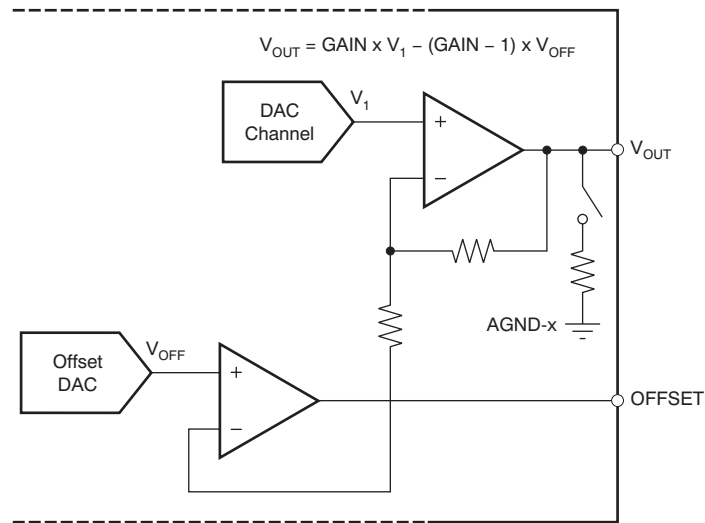

**Figure 98. Output Amplifier and Offset DAC**

## OUTPUT AMPLIFIERS

The output amplifiers can swing to 0.5V below the positive supply and 0.5V above the negative supply. This condition limits how much the output can be offset for a given reference voltage. The maximum range of the output for  $\pm 17V$  power and a +5.5V reference is  $-16.5V$  to  $+16.5V$  for gain = 6.

Each output amplifier is implemented with individual over-current protection. The amplifier is clamped at 8mA, even if the output current goes over 8mA.



## GENERAL-PURPOSE INPUT/OUTPUT PINS (GPIO-0 to GPIO-2)

The GPIO pins are general-purpose, bidirectional, digital input/outputs, as shown in Figure 99. When a GPIO pin acts as an output, the pin status is determined by the corresponding GPIO bit in the GPIO Register. The pin output is high-impedance when the GPIO bit is set to '1', and is logic low when the GPIO bit is cleared to '0'. Note that a pull-up resistor to IOV<sub>DD</sub> is required when using a GPIO pin as an output. When a GPIO pin acts as an input, the digital value on the pin is acquired by reading the corresponding GPIO bit. After power-on reset, or any forced hardware or software reset, the GPIO bits are set to '1', and the GPIO pins are in a high-impedance state. If not used, the GPIO pins must be tied to either DGND or to IOV<sub>DD</sub> through a pull-up resistor. Leaving the GPIO pins floating can cause high IOV<sub>DD</sub> supply currents.

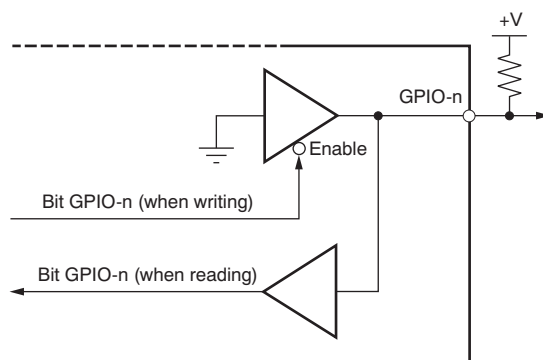

**Figure 99. GPIO-n Pin**

## ANALOG OUTPUT PIN ( $\overline{\text{CLR}}$ )

The  $\overline{\text{CLR}}$  pin is an active low input that should be high for normal operation. When this pin is in logic '0', all V<sub>OUT</sub> outputs connect to AGND-x through internal 15kΩ resistors and are cleared to 0V, and the output buffer is in a Hi-Z state. While  $\overline{\text{CLR}}$  is low, all LDAC pulses are ignored. When  $\overline{\text{CLR}}$  is taken high again while the LDAC is high, the DAC outputs remain cleared until LDAC is taken low. However, if LDAC is tied low, taking  $\overline{\text{CLR}}$  back to high sets the DAC output to the level defined by the value of the DAC latch. The contents of the Zero Registers, Gain Registers, Input Data Registers, DAC Data Registers, and DAC latches are not affected by taking  $\overline{\text{CLR}}$  low.

## POWER-ON RESET

The DAC8218 contains a power-on reset circuit that controls the output during power-on and power down. This feature is useful in applications where the known state of the DAC output during power-on is important. The Offset DAC Registers, DAC Data Registers, and DAC latches are loaded with the value defined by the RSTSEL pin, as shown in [Table 7](#). The Gain Registers and Zero Registers are loaded with default values. The Input Data Register is reset to 0000h, independent of the RSTSEL state.

**Table 7. Bipolar Output Reset Values for Dual Power-Supply Operation**

| RSTSEL PIN        | $\overline{\text{USB}}/\text{BTC}$ PIN | INPUT FORMAT    | VALUE OF DAC DATA REGISTER AND DAC LATCH | VALUE OF OFFSET DAC REGISTER FOR GAIN = 6 <sup>(1)</sup> | V <sub>OUT</sub> |
|-------------------|--|-----------------|--|--|------------------|
| DGND              | DGND                                   | Straight Binary | 0000h                                    | 2666h  | –Full-Scale      |
| IOV <sub>DD</sub> | DGND                                   | Straight Binary | 2000h                                    | 2666h  | 0 V              |
| DGND              | IOV <sub>DD</sub>                      | Twos Complement | 2000h                                    | 0666h  | –Full-Scale      |
| IOV <sub>DD</sub> | IOV <sub>DD</sub>                      | Twos Complement | 0000h                                    | 0666h  | 0 V              |

(1) Offset DAC A and Offset DAC B are trimmed in manufacturing to minimize the error for symmetrical output. The default value may vary no more than  $\pm 3$  LSB from the nominal number listed in this table.

In single-supply operation, the Offset DAC is turned off and the output is unipolar. The power-on reset is defined as shown in [Table 8](#).

**Table 8. Unipolar Output Reset Values for Single Power-Supply Operation**

| RSTSEL PIN        | $\overline{\text{USB}}/\text{BTC}$ PIN | INPUT FORMAT    | VALUE OF DAC DATA REGISTER AND DAC LATCH | V <sub>OUT</sub> |
|-------------------|--|-----------------|--|------------------|
| DGND              | DGND                                   | Straight Binary | 0000h                                    | 0 V              |
| IOV <sub>DD</sub> | DGND                                   | Straight Binary | 2000h                                    | Midscale         |
| DGND              | IOV <sub>DD</sub>                      | Twos Complement | 2000h                                    | 0 V              |
| IOV <sub>DD</sub> | IOV <sub>DD</sub>                      | Twos Complement | 0000h                                    | Midscale         |

## HARDWARE RESET

When the  $\overline{\text{RST}}$  pin is low, the device is in hardware reset. All the analog outputs (V<sub>OUT-0</sub> to V<sub>OUT-7</sub>), the DAC registers, and the DAC latches are set to the reset values defined by the RSTSEL pin as shown in [Table 7](#) and [Table 8](#). In addition, the Gain and Zero Registers are loaded with default values, communication is disabled, and the signals on  $\overline{\text{CS}}$  and SDI are ignored (note that SDO is in a high-impedance state). The Input Data Register is reset to 0000h, independent of the RSTSEL state. On the rising edge of  $\overline{\text{RST}}$ , the analog outputs (V<sub>OUT-0</sub> to V<sub>OUT-7</sub>) maintain the reset value as defined by the RSTSEL pin until a new value is programmed. After  $\overline{\text{RST}}$  goes high, the serial interface returns to normal operation.  $\overline{\text{CS}}$  must be set to a logic high whenever  $\overline{\text{RST}}$  is used.

## UPDATING THE DAC OUTPUTS

Depending on the status of both  $\overline{CS}$  and  $\overline{LDAC}$ , and after data have been transferred into the DAC Data registers, the DAC outputs can be updated either in asynchronous mode or synchronous mode. This update mode is established at power-on. If asynchronous mode is desired, the  $\overline{LDAC}$  pin must be permanently tied low before power is applied to the device. If synchronous mode is desired,  $\overline{LDAC}$  must be logic high before and during power-on.

The DAC8218 updates a DAC latch only if it has been accessed since the last time  $\overline{LDAC}$  was brought low or if the LD bit is set to '1', thereby eliminating any unnecessary glitch. Any DAC channels that were not accessed are not loaded again. When the DAC latch is updated, the corresponding output changes to the new level immediately.

### Asynchronous Mode

In this mode, the  $\overline{LDAC}$  pin is set low at power-up. This action places the DAC8218 into Asynchronous mode, and the LD bit and  $\overline{LDAC}$  signal are ignored. When the correction engine is off (SCE bit = '0'), the DAC Data Registers and DAC latches are updated immediately when  $\overline{CS}$  goes high. When the correction engine is on (SCE bit = '1'), each DAC latch is updated individually when the correction engine updates the corresponding DAC Data Register.

### Synchronous Mode

To use this mode, set  $\overline{LDAC}$  high before  $\overline{CS}$  goes low, and then take  $\overline{LDAC}$  low or set the LD bit to '1' after  $\overline{CS}$  goes high. If  $\overline{LDAC}$  goes low or if the LD bit is set to '1' when SCE = '0', all DAC latches are updated simultaneously. If  $\overline{LDAC}$  goes low or if the LD bit is set to '1' when SCE = '1', all DAC latches are updated simultaneously after the correction engine has updated the corresponding DAC register.

In this mode, when  $\overline{LDAC}$  stays high, the DAC latch is not updated; therefore, the DAC output does not change. The DAC latch is updated by taking  $\overline{LDAC}$  low (or by setting the LD bit in the Configuration Register to '1') any time after the delay of  $t_9$  from the rising edge of  $\overline{CS}$ . If the timing requirement of  $t_9$  is not satisfied, invalid data are loaded. Refer to the [Timing Diagrams](#) and the Configuration Register ([Table 11](#)) for details.

## MONITOR OUTPUT PIN ( $V_{MON}$ )

The  $V_{MON}$  pin is the channel monitor output. It can be either high-impedance or monitor any one of the DAC outputs, auxiliary analog inputs, offset DAC outputs, or reference buffer outputs. The channel monitor function consists of an analog multiplexer addressed via the serial interface, allowing any channel output, reference buffer output, auxiliary analog inputs, or offset DAC output to be routed to the  $V_{MON}$  pin for monitoring using an external ADC. The monitor function is controlled by the Monitor Register, which allows the monitor output to be enabled or disabled. When disabled, the monitor output is high-impedance; therefore, several monitor outputs may be connected in parallel with only one enabled at a time.

Note that the multiplexer is implemented as a series of analog switches. Care should be taken to ensure the maximum current from the  $V_{MON}$  pin must not be greater than the given specification because this could conceivably cause a large amount of current to flow from the input of the multiplexer (that is, from  $V_{OUT-X}$ ) to the output of the multiplexer ( $V_{MON}$ ). Refer to the *Monitor Register* section and [Table 12](#) for more details.

## ANALOG INPUT PINS (AIN-0 and AIN-1)

Pins AIN-0 and AIN-1 are two analog inputs that directly connect to the analog mux of the analog monitor output. When AIN-0 or AIN-1 is accessed, it is routed via the mux to the  $V_{MON}$  pin. Thus, one external ADC channel can monitor eight DACs plus two extra external analog signals, AIN-0 and AIN-1.

## POWER-DOWN MODE

The DAC8218 is implemented with a power-down function to reduce power consumption. Either the entire device or each individual group can be put into power-down mode. If the proper power-down bit (PD-x) in the Configuration Register is set to '1', the individual group is put into power down mode. During power-down mode, the analog outputs ( $V_{OUT-0}$  to  $V_{OUT-7}$ ) connect to AGND-X through an internal 15k $\Omega$  resistor, and the output buffer is in Hi-Z status. When the entire device is in power-down, the bus interface remains active in order to continue communication and receive commands from the host controller, but all other circuits are powered down. The host controller can wake the device from power-down mode and return to normal operation by clearing the PD-x bit; it takes 200 $\mu$ s or less for recovery to complete.

## POWER-ON RESET SEQUENCING

The DAC8218 permanently latches the status of some of the digital pins at power-on. These digital levels should be well-defined before or while the digital supply voltages are applied. Therefore, it is advised to have a pull up resistor to IOV<sub>DD</sub> for the digital initialization pins (LDAC, CLR, RST, CS, and RSTSEL) to ensure that these levels are set correctly while the digital supplies are raised.

For proper power-on initialization of the device, IOV<sub>DD</sub> and the digital pins must be applied before or at the same time as DV<sub>DD</sub>. If possible, it is preferred that IOV<sub>DD</sub> and DV<sub>DD</sub> can be connected together in order to simplify the supply sequencing requirements. Pull-up resistors should go to either supply. AV<sub>DD</sub> should be applied after the digital supplies (IOV<sub>DD</sub> and DV<sub>DD</sub>) and digital initialization pins (LDAC, CLR, RST, CS, and RSTSEL). AV<sub>SS</sub> can be applied at the same time as or after AV<sub>DD</sub>. The REF-x pins must be applied last.

## SERIAL INTERFACE

The DAC8218 is controlled over a versatile, three-wire serial interface that operates at clock rates of up to 50MHz and is compatible with SPI, QSPI™, Microwire™, and DSP™ standards.

### SPI Shift Register

The SPI Shift Register is 24 bits wide. Data are loaded into the device MSB first as a 24-bit word under the control of the serial clock input, SCLK. The SPI Shift Register consists of a read/write bit, five register address bits, 14 data bits, and four reserve bits for future devices, as shown in [Table 9](#). The falling edge of  $\overline{CS}$  starts the communication cycle. The data are latched into the SPI Shift Register on the falling edge of SCLK while  $\overline{CS}$  is low. When  $\overline{CS}$  is high, the SCLK and SDI signals are blocked and the SDO pin is in a high-impedance state. The contents of the SPI shifter register are decoded and transferred to the proper internal registers on the rising edge of  $\overline{CS}$ . The timing for this operation is shown in the [Timing Diagrams](#) section.

The serial interface works with both a continuous and non-continuous serial clock. A continuous SCLK source can only be used if  $\overline{CS}$  is held low for the correct number of clock cycles. In gated clock mode, a burst clock containing the exact number of clock cycles must be used and  $\overline{CS}$  must be taken high after the final clock in order to latch the data.

The serial interface requires  $\overline{CS}$  to be logic high during the power-on sequencing; therefore, it is advised to have a pullup resistor to IOV<sub>DD</sub> on the  $\overline{CS}$  pin. Refer to the [Power-On Reset Sequencing](#) section for further details.

### Stand-Alone Operation

The serial clock can be a continuous or a gated clock. The first falling edge of  $\overline{CS}$  starts the operation cycle. Exactly 24 falling clock edges must be applied before  $\overline{CS}$  is brought back high again. If  $\overline{CS}$  is brought high before the 24th falling SCLK edge, then the data written are not transferred into the internal registers. If more than 24 falling SCLK edges are applied before  $\overline{CS}$  is brought high, then the last 24 bits are used. The device internal registers are updated from the Shift Register on the rising edge of  $\overline{CS}$ . In order for another serial transfer to take place,  $\overline{CS}$  must be brought low again.

When the data have been transferred into the chosen register of the addressed DAC, all DAC latches and analog outputs can be updated by taking  $\overline{LDAC}$  low.

### Daisy-Chain Operation

For systems that contain more than one device, the SDO pin can be used to daisy-chain multiple devices together. Daisy-chain operation can be useful in system diagnostics and in reducing the number of serial interface lines. Note that before daisy-chain operation can begin, the SDO pin must be enabled by setting the SDO disable bit (DSDO) in the Configuration Register to '0'; this bit is cleared by default.

The DAC8218 provides two modes for daisy-chain operation: normal and sleep. The SLEEP bit in the SPI Mode register determines which mode is used.

In Normal mode (SLEEP bit = '0'), the data clocked into the SDI pin are transferred into the Shift Register. The first falling edge of  $\overline{CS}$  starts the operating cycle. SCLK is continuously applied to the SPI Shift Register when  $\overline{CS}$  is low. If more than 24 clock pulses are applied, the data ripple out of the Shift Register and appear on the SDO line. These data are clocked out on the rising edge of SCLK and are valid on the falling edge. By connecting the SDO pin of the first device to the SDI input of the next device in the chain, a multiple-device interface is constructed. Each device in the system requires 24 clock pulses. Therefore, the total number of clock cycles must equal  $24 \times N$ , where  $N$  is the total number of DAC8218s in the chain. When the serial transfer to all devices is complete,  $\overline{CS}$  is taken high. This action latches the data from the SPI Shift Registers to the device internal registers for each device in the daisy-chain, and prevents any further data from being clocked in. The serial clock can be a continuous or a gated clock. Note that a continuous SCLK source can only be used if  $\overline{CS}$  is held low for the correct number of clock cycles. For gated clock mode, a burst clock containing the exact number of clock cycles must be used and  $\overline{CS}$  must be taken high after the final clock in order to latch the data.

In Sleep mode (SLEEP bit = '1'), the data clocked into SDI are routed to the SDO pin directly; the Shift Register is bypassed. The first falling edge of  $\overline{CS}$  starts the operating cycle. When SCLK is continuously applied with  $\overline{CS}$  low, the data clocked into the SDI pin appear on the SDO pin almost immediately (with approximately a 5 ns delay; see the [Timing Diagrams](#) section); there is no 24 clock delay, as there is in normal operating mode. While in Sleep mode, no data bits are clocked into the Shift Register, and the device does not receive any new data or commands. Putting the device into Sleep mode eliminates the 24 clock delay from SDI to SDO caused by the

Shift Register, thus greatly speeding up the data transfer. For example, consider three DAC8218s (A, B, and C) in a daisy-chain configuration. The data from the SPI controller are transferred first to A, then to B, and finally to C. In normal daisy-chain operation, a total of 72 clocks are needed to transfer one word to C. However, if A and B are placed into Sleep mode, the first 24 data bits are directly transferred to C (through A and B); therefore, only 24 clocks are needed.

To wake the device up from sleep mode and return to normal operation, either one of following methods can be used:

1. Pull the  $\overline{\text{WAKEUP}}$  pin low, which forces the SLEEP bit to '0' and returns the device to normal operating mode.
2. Use the W2 bit and the  $\overline{\text{CS}}$  pin.

When the W2 bit = '1', if  $\overline{\text{CS}}$  is applied with no more than one falling edge of SCLK, then the rising edge of  $\overline{\text{CS}}$  wakes the device from sleep mode back to normal operation. However, the device will not wake-up if more than one falling edge of SCLK exists while  $\overline{\text{CS}}$  is low.

### Read-Back Operation

The READ command is used to start read-back operation. However, before read-back operation can be initiated, the SDO pin must be enabled by setting the DSDO bit in the Configuration Register to '0'; this bit is cleared by default. Read-back operation is then started by executing a READ command (R/W bit = '1', see Table 9). Bits A4 to A0 in the READ command select the register to be read. The remaining data in the command are *don't care* bits. During the next SPI operation, the data appearing on the SDO output are from the previously addressed register. For a read of a single register, a NOP command can be used to clock out the data from the selected register on SDO. Multiple registers can be read if multiple READ commands are issued. The readback diagram in Figure 100 shows the read-back sequence.

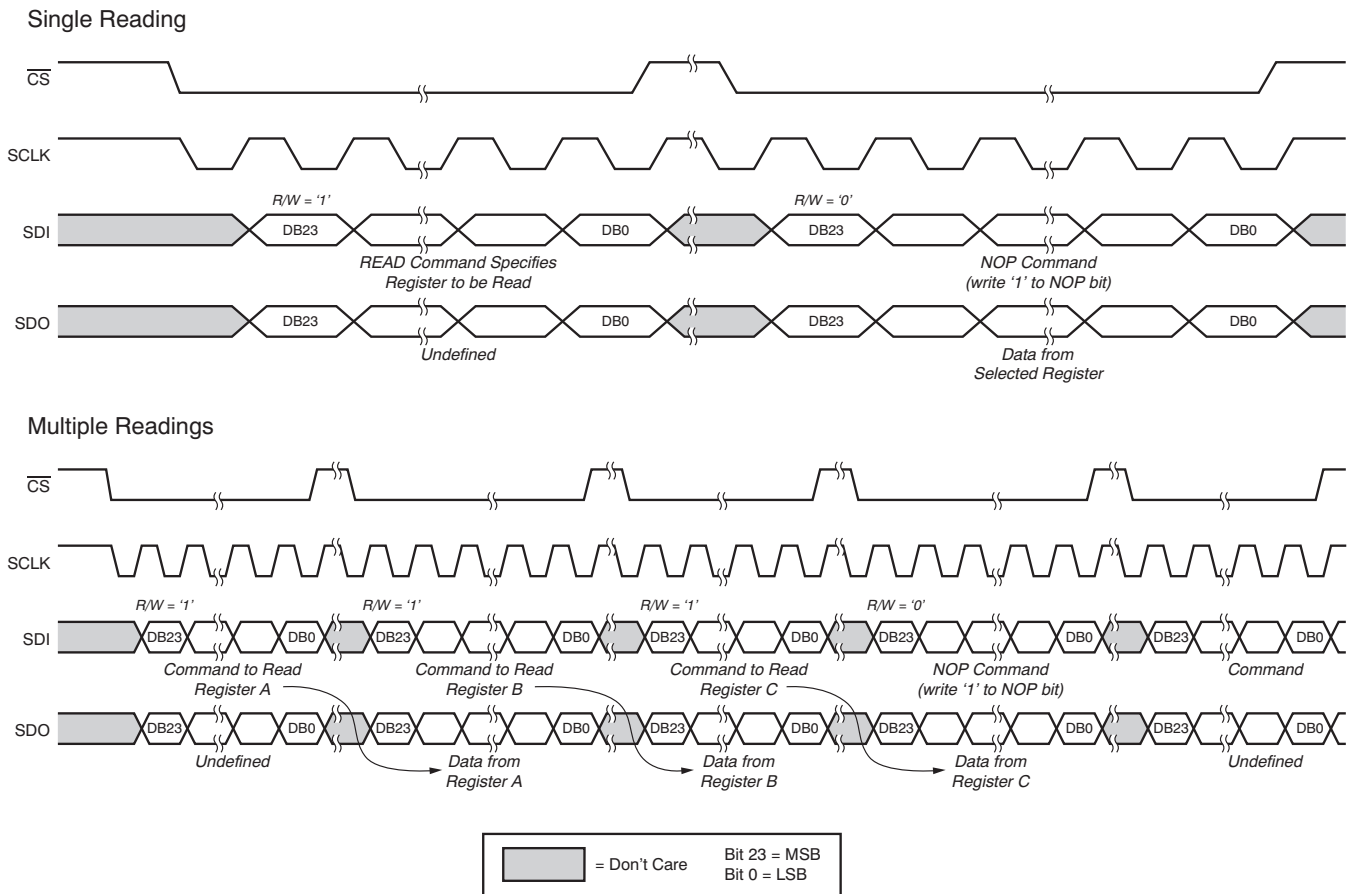

Figure 100. Read-Back Operation

## SPI SHIFT REGISTER

The SPI Shift Register is 24 bits wide, as shown in [Table 9](#). The register mapping is shown in [Table 10](#); X = don't care—writing to it has no effect, reading it returns '0'.

**Table 9. Shift Register Format**

| MSB  |      |      |      |      |      |      |      |          |         |
|------|------|------|------|------|------|------|------|----------|---------|
| DB23 | DB22 | DB21 | DB20 | DB19 | DB18 | DB17 | DB16 | DB15:DB2 | DB1:DB0 |
| R/W  | X    | X    | A4   | A3   | A2   | A1   | A0   | DATA     | X       |

**R/W** Indicates a read from or a write to the addressed register.

R/W = '0' sets a write operation and the data are written to the specified register.

R/W = '1' sets a read-back operation. Bits A4 to A0 select the register to be read. The remaining bits are *don't care* bits. During the next SPI operation, the data appearing on SDO pin are from the previously addressed register.

**A4:A0** Address bits that specify which register is accessed.

**DATA** 14 data bits

**Table 10. Register Map**

| ADDRESS BITS |    |    |    |    | DATA BITS   |                         |        |                  |      |     |    |        |        |      |     |    |                  |                        | REGISTER         |
|--------------|----|----|----|----|---|-------------------------|--------|------------------|------|-----|----|--------|--------|------|-----|----|------------------|------------------------|------------------|
| A4           | A3 | A2 | A1 | A0 | D15   | D14                     | D13    | D12              | D11  | D10 | D9 | D8     | D7     | D6   | D5  | D4 | D3:D0            |                        |                  |
| 0            | 0  | 0  | 0  | 0  | A/B   | LD                      | RST    | PD-A             | PD-B | SCE | X  | GAIN-A | GAIN-B | DSDO | NOP | W2 | X <sup>(1)</sup> | Configuration Register |                  |
| 0            | 0  | 0  | 0  | 1  | Analog Monitor Select                                 |                         |        |                  |      |     |    |        |        |      |     |    |                  | X <sup>(1)</sup>       | Monitor Register |
| 0            | 0  | 0  | 1  | 0  | GPIO-2  | GPIO-1                  | GPIO-0 | X <sup>(1)</sup> |      |     |    |        |        |      |     |    |                  |                        | GPIO Register    |
| 0            | 0  | 0  | 1  | 1  | OS13:OS0, X, X <sup>(2)</sup>                         |                         |        |                  |      |     |    |        |        |      |     |    |                  | Offset DAC-A Data      |                  |
| 0            | 0  | 1  | 0  | 0  | OS13:OS0, X, X <sup>(2)</sup>                         |                         |        |                  |      |     |    |        |        |      |     |    |                  | Offset DAC-B Data      |                  |
| 0            | 0  | 1  | 0  | 1  | Reserved <sup>(3)</sup>                               |                         |        |                  |      |     |    |        |        |      |     |    |                  | Reserved               |                  |
| 0            | 0  | 1  | 1  | 0  | SLEEP   | Reserved <sup>(3)</sup> |        |                  |      |     |    |        |        |      |     |    |                  |                        | SPI MODE         |
| 0            | 0  | 1  | 1  | 1  | DB13:DB0, X, X  |                         |        |                  |      |     |    |        |        |      |     |    |                  | Broadcast              |                  |
| 0            | 1  | 0  | 0  | 0  | DB13:DB0, X, X  |                         |        |                  |      |     |    |        |        |      |     |    |                  | DAC-0                  |                  |
| 0            | 1  | 0  | 0  | 1  | DB13:DB0, X, X  |                         |        |                  |      |     |    |        |        |      |     |    |                  | DAC-1                  |                  |
| 0            | 1  | 0  | 1  | 0  | DB13:DB0, X, X  |                         |        |                  |      |     |    |        |        |      |     |    |                  | DAC-2                  |                  |
| 0            | 1  | 0  | 1  | 1  | DB13:DB0, X, X  |                         |        |                  |      |     |    |        |        |      |     |    |                  | DAC-3                  |                  |
| 0            | 1  | 1  | 0  | 0  | DB13:DB0, X, X  |                         |        |                  |      |     |    |        |        |      |     |    |                  | DAC-4                  |                  |
| 0            | 1  | 1  | 0  | 1  | DB13:DB0, X, X  |                         |        |                  |      |     |    |        |        |      |     |    |                  | DAC-5                  |                  |
| 0            | 1  | 1  | 1  | 0  | DB13:DB0, X, X  |                         |        |                  |      |     |    |        |        |      |     |    |                  | DAC-6                  |                  |
| 0            | 1  | 1  | 1  | 1  | DB13:DB0, X, X  |                         |        |                  |      |     |    |        |        |      |     |    |                  | DAC-7                  |                  |
| 1            | 0  | 0  | 0  | 0  | Z13:Z0, X, X, default = 0 (0000h), twos complement    |                         |        |                  |      |     |    |        |        |      |     |    |                  | Zero Register-0        |                  |
| 1            | 1  | 0  | 0  | 0  | G13:G0, X, X, default = 8192 (2000h), straight binary |                         |        |                  |      |     |    |        |        |      |     |    |                  | Gain Register-0        |                  |
| 1            | 0  | 0  | 0  | 1  | Z13:Z0, X, X, default = 0 (0000h), twos complement    |                         |        |                  |      |     |    |        |        |      |     |    |                  | Zero Register-1        |                  |
| 1            | 1  | 0  | 0  | 1  | G13:G0, X, X, default = 8192 (2000h), straight binary |                         |        |                  |      |     |    |        |        |      |     |    |                  | Gain Register-1        |                  |
| 1            | 0  | 0  | 1  | 0  | Z13:Z0, X, X, default = 0 (0000h), twos complement    |                         |        |                  |      |     |    |        |        |      |     |    |                  | Zero Register-2        |                  |
| 1            | 1  | 0  | 1  | 0  | G13:G0, X, X, default = 8192 (2000h), straight binary |                         |        |                  |      |     |    |        |        |      |     |    |                  | Gain Register-2        |                  |
| 1            | 0  | 0  | 1  | 1  | Z13:Z0, X, X, default = 0 (0000h), twos complement    |                         |        |                  |      |     |    |        |        |      |     |    |                  | Zero Register-3        |                  |
| 1            | 1  | 0  | 1  | 1  | G13:G0, X, X, default = 8192 (2000h), straight binary |                         |        |                  |      |     |    |        |        |      |     |    |                  | Gain Register-3        |                  |
| 1            | 0  | 1  | 0  | 0  | Z13:Z0, X, X, default = 0 (0000h), twos complement    |                         |        |                  |      |     |    |        |        |      |     |    |                  | Zero Register-4        |                  |
| 1            | 1  | 1  | 0  | 0  | G13:G0, X, X, default = 8192 (2000h), straight binary |                         |        |                  |      |     |    |        |        |      |     |    |                  | Gain Register-4        |                  |
| 1            | 0  | 1  | 0  | 1  | Z13:Z0, X, X, default = 0 (0000h), twos complement    |                         |        |                  |      |     |    |        |        |      |     |    |                  | Zero Register-5        |                  |
| 1            | 1  | 1  | 0  | 1  | G13:G0, X, X, default = 8192 (2000h), straight binary |                         |        |                  |      |     |    |        |        |      |     |    |                  | Gain Register-5        |                  |
| 1            | 0  | 1  | 1  | 0  | Z13:Z0, X, X, default = 0 (0000h), twos complement    |                         |        |                  |      |     |    |        |        |      |     |    |                  | Zero Register-6        |                  |
| 1            | 1  | 1  | 1  | 0  | G13:G0, X, X, default = 8192 (2000h), straight binary |                         |        |                  |      |     |    |        |        |      |     |    |                  | Gain Register-6        |                  |
| 1            | 0  | 1  | 1  | 1  | Z13:Z0, X, X, default = 0 (0000h), twos complement    |                         |        |                  |      |     |    |        |        |      |     |    |                  | Zero Register-7        |                  |
| 1            | 1  | 1  | 1  | 1  | G13:G0, X, X, default = 8192 (2000h), straight binary |                         |        |                  |      |     |    |        |        |      |     |    |                  | Gain Register-7        |                  |

- (1) X = don't care—writing to this bit has no effect; reading the bit returns '0'.
- (2) Table 7 lists the default values for a dual power supply. Offset DAC A and Offset DAC B are trimmed in manufacturing to minimize the error for symmetrical output. The default value may vary no more than ±3 LSB from the nominal number listed in Table 7. For a single power supply, the Offset DACs are turned off.
- (3) Writing to a reserved bit has no effect; reading the bit returns '0'.



## INTERNAL REGISTERS

The DAC8218 internal registers consist of the Configuration Register, the Monitor Register, the DAC Input Data Registers, the Zero Registers, the DAC Data Registers, and the Gain Registers, and are described in the following section.

The Configuration Register specifies which actions are performed by the device. [Table 11](#) shows the details.

**Table 11. Configuration Register (Default = 2000h)**

| BIT   | NAME   | DEFAULT VALUE | DESCRIPTION  |
|-------|--------|---------------|--|
| D15   | A/B    | 1             | A/B bit.<br>When A/B = '0', reading DAC-x returns the value in the Input Data Register.<br>When A/B = '1', reading DAC-x returns the value in the DAC Data Register.<br>When the correction engine is enabled, the data returned from the Input Data Register is the original data written to the bus, and the value in the DAC Data Register is the corrected data.   |
| D14   | LD     | 0             | Synchronously update DACs bit.<br>When LDAC is tied high, setting LD = '1' at any time after the write operation and the correction process complete synchronously updates all DAC latches with the content of the corresponding DAC Data Register, and sets $V_{OUT}$ to a new level. The DAC8218 updates the DAC latch only if it has been accessed since the last time LDAC was brought low or the LD bit was set to '1', thereby eliminating unnecessary glitch. Any DACs that were not accessed are not reloaded. After updating, the bit returns to '0'. When the correction engine is turned off, bit LD can be set to '1' any time after the writing operation is complete; the DAC latch is immediately updated when bit LD is set. When the LDAC pin is tied low, this bit is ignored. |
| D13   | RST    | 0             | Software reset bit.<br>Set the RST bit to '1' to reset the device; functions the same as a hardware reset. After reset completes, the RST bit returns to '0'.  |
| D12   | PD-A   | 0             | Power-down bit for Group A (DAC-0, DAC-1, DAC-2, and DAC-3).<br>Setting the PD-A bit to '1' places Group A (DAC-0, DAC-1, DAC-2, and DAC-3) into power-down operation. All output buffers are in Hi-Z and all analog outputs ( $V_{OUT-X}$ ) connect to AGND-A through an internal 15-k $\Omega$ resistor. The interface is still active.<br>Setting the PD-A bit to '0' returns group A to normal operation.  |
| D11   | PD-B   | 0             | Power-down bit for Group B (DAC-4, DAC-5, DAC-6, and DAC-7).<br>Setting the PD-B bit to '1' places Group B (DAC-4, DAC-5, DAC-6, and DAC-7) into power-down operation. All output buffers are in Hi-Z and all analog outputs ( $V_{OUT-X}$ ) connect to AGND-B through an internal 15-k $\Omega$ resistor. The interface is still active.<br>Setting the PD-B bit to '0' returns group B to normal operation.  |
| D10   | SCE    | 0             | System-calibration enable bit.<br>Set the SCE bit to '1' to enable the correction engine. When the engine is enabled, the input data are adjusted by the correction engine according to the contents of the corresponding Gain Register and Zero Register. The results are transferred to the corresponding DAC Data Register, and finally loaded into the DAC latch, which sets the $V_{OUT-X}$ pin output level.<br>Set the SCE bit to '0' to turn off the correction engine. When the engine is turned off, the input data are transferred to the corresponding DAC Data Register immediately, and then loaded into the DAC latch, which sets the output voltage. Refer to the <a href="#">User Calibration for Zero-Code Error and Gain Error</a> section for details.                       |
| D9    | —      | 0             | Reserved. Writing to this bit has no effect; reading this bit returns '0'.   |
| D8    | GAIN-A | 0             | Gain bit for Group A (DAC-0, DAC-1, DAC-2, and DAC-3). Updating this bit to a new value automatically resets the Offset DAC-A Register to the factory-trimmed value for the new gain setting.<br>Set the GAIN-A bit to '0' for an output span = 6 $\times$ REF-A.<br>Set the GAIN-A bit to '1' for an output span = 4 $\times$ REF-A.  |
| D7    | GAIN-B | 0             | Gain bit for Group B (DAC-4, DAC-5, DAC-6, and DAC-7). Updating this bit to a new value automatically resets the Offset DAC-B Register to the factory-trimmed value for the new gain setting.<br>Set the GAIN-B bit to '0' for an output span = 6 $\times$ REF-B.<br>Set the GAIN-B bit to '1' for an output span = 4 $\times$ REF-B.  |
| D6    | DSDO   | 0             | Disable SDO bit.<br>Set the DSDO bit to '0' to enable the SDO pin (default). The SDO pin works as a normal SPI output.<br>Set the DSDO bit to '1' to disable the SDO pin. The SDO pin is always in a Hi-Z state no matter what the status of the $\overline{CS}$ pin is.   |
| D5    | NOP    | 0             | No operation bit.<br>During a write operation, setting the NOP bit to '1' has no effect (the bit returns to '0' when the write operation completes).<br>Setting the NOP bit to '0', returns the device to normal operation.<br>During a read operation, the bit always returns "0"   |
| D4    | W2     | 0             | Second wake-up operation bit.<br>If the WAKEUP pin is high, an alternative method to wake-up the device from sleep in SPI is by using the $\overline{CS}$ pin. When W2 = '1', the rising edge of $\overline{CS}$ restores the device from sleep mode to normal operation, if no more than one falling edge of SCLK exists while $\overline{CS}$ is low. However, the device will not wake up if more than one falling edge of SCLK exists. Setting the W2 bit to '0' disables this function, and the rising edge of $\overline{CS}$ does not wake up the device.<br>If the WAKEUP is low, this bit is ignored and the device is always in normal mode.   |
| D3:D0 | —      | 0             | Reserved. Writing to these bits has no effect; reading these bits returns '0'.   |

### Monitor Register (default = 0000h).

The Monitor Register selects one of the DAC outputs, auxiliary analog inputs, reference buffer outputs, or offset DAC outputs to be monitored through the  $V_{MON}$  pin. When bits [D15:D4] = '0', the monitor is disabled and  $V_{MON}$  is in a Hi-Z state.

Note that if any value is written other than those specified in Table 12, the Monitor Register stores the invalid value; however, the  $V_{MON}$  pin is forced into a Hi-Z state.

**Table 12. Monitor Register (Default = 0000h)**

| D15 | D14 | D13 | D12 | D11 | D10 | D9 | D8 | D7 | D6 | D5 | D4 | D3:D0            | $V_{MON}$ CONNECTS TO                     |
|-----|-----|-----|-----|-----|-----|----|----|----|----|----|----|------------------|---|
| 0   | 0   | 0   | 0   | 0   | 0   | 0  | 0  | 0  | 0  | 0  | 1  | X <sup>(1)</sup> | Reference buffer B output                 |
| 0   | 0   | 0   | 0   | 0   | 0   | 0  | 0  | 0  | 0  | 1  | 0  | X                | Reference buffer A output                 |
| 0   | 0   | 0   | 0   | 0   | 0   | 0  | 0  | 0  | 1  | 0  | 1  | X                | Offset DAC B output                       |
| 0   | 0   | 0   | 0   | 0   | 0   | 0  | 0  | 0  | 1  | 1  | 0  | X                | Offset DAC A output                       |
| 0   | 0   | 0   | 0   | 0   | 0   | 0  | 0  | 0  | 1  | 0  | 0  | X                | AIN-0                                     |
| 0   | 0   | 0   | 0   | 0   | 0   | 0  | 0  | 1  | 0  | 0  | 0  | X                | AIN-1                                     |
| 0   | 0   | 0   | 0   | 0   | 0   | 0  | 1  | 0  | 0  | 0  | 0  | X                | DAC-0                                     |
| 0   | 0   | 0   | 0   | 0   | 0   | 1  | 0  | 0  | 0  | 0  | 0  | X                | DAC-1                                     |
| 0   | 0   | 0   | 0   | 0   | 1   | 0  | 0  | 0  | 0  | 0  | 0  | X                | DAC-2                                     |
| 0   | 0   | 0   | 0   | 1   | 0   | 0  | 0  | 0  | 0  | 0  | 0  | X                | DAC-4                                     |
| 0   | 0   | 0   | 1   | 0   | 0   | 0  | 0  | 0  | 0  | 0  | 0  | X                | DAC-4                                     |
| 0   | 0   | 1   | 0   | 0   | 0   | 0  | 0  | 0  | 0  | 0  | 0  | X                | DAC-5                                     |
| 0   | 1   | 0   | 0   | 0   | 0   | 0  | 0  | 0  | 0  | 0  | 0  | X                | DAC-6                                     |
| 1   | 0   | 0   | 0   | 0   | 0   | 0  | 0  | 0  | 0  | 0  | 0  | X                | DAC-7                                     |
| 0   | 0   | 0   | 0   | 0   | 0   | 0  | 0  | 0  | 0  | 0  | 0  | X                | Monitor function disabled, Hi-Z (default) |

(1) X = don't care.

### GPIO Register (default = 3800h).

The GPIO Register determines the status of each GPIO pin.

| D15    | D14    | D13    | D12 | D11 | D10 | D9 | D8 | D7 | D6 | D5 | D4 | D3 | D2 | D1 | D0 |
|--------|--------|--------|-----|-----|-----|----|----|----|----|----|----|----|----|----|----|
| GPIO-2 | GPIO-1 | GPIO-0 | X   | X   | X   | X  | X  | X  | X  | X  | X  | X  | X  | X  | X  |

**GPIO-2:0** For write operations, the GPIO-n pin operates as an output. Writing a '1' to the GPIO-n bit sets the GPIO-n pin to high impedance, and writing a '0' sets the GPIO-n pin to logic low. An external pull-up resistor is required when using the GPIO-n pin as an output.

For read operations, the GPIO-n pin operates as an input. Read the GPIO-n bit to receive the status of the corresponding GPIO-n pin. Reading a '0' indicates that the GPIO-n pin is low, and reading a '1' indicates that the GPIO-n pin is high.

After power-on reset, or any forced hardware or software reset, all GPIO-n bits are set to '1', and the GPIO pins are in a high impedance state.

**Offset DAC-A/B Registers** (default = 2666h for dual supplies or 0000h for single supplies).

The Offset DAC-A and Offset DAC-B registers contain, by default, the factory-trimmed Offset DAC code providing optimal offset and span for symmetric bipolar operation when dual supplies are detected, and contain code 0000h when a single supply is detected.

| D15  | D14  | D13  | D12  | D11 | D10 | D9  | D8  | D7  | D6  | D5  | D4  | D3  | D2  | D1 | D0 |
|------|------|------|------|-----|-----|-----|-----|-----|-----|-----|-----|-----|-----|----|----|
| OS13 | OS12 | OS11 | OS10 | OS9 | OS8 | OS7 | OS6 | OS5 | OS4 | OS3 | OS2 | OS1 | OS0 | X  | X  |

**OS13:0** For dual-supply operation, the default code for a gain of 6 is 2666h with a  $\pm 3$  LSB variation, depending on the linearity of each Offset DAC. The default code for a gain of 4 is 2AABh with a  $\pm 3$  LSB variation. The default codes of Offset DAC-A and Offset DAC-B registers are independently factory trimmed for both gains of 6 and 4.

When single-supply operation is present, writing to these registers is ignored and reading returns 0000h. When dual-supply operation is present, updating the GAIN-A (GAIN-B) bit on the configuration register automatically reloads the factory-trimmed code into the Offset DAC-A (Offset DAC-B) register for the new GAIN-A (GAIN-B) setting. See the [Offset DACs](#) for further details.

**SPI MODE Register** (default = 0000h).

The SPI Mode Register is used to put the device into SPI sleep mode.

| D15   | D14 | D13 | D12 | D11 | D10 | D9 | D8 | D7 | D6 | D5 | D4 | D3 | D2 | D1 | D0 |
|-------|-----|-----|-----|-----|-----|----|----|----|----|----|----|----|----|----|----|
| SLEEP | X   | X   | X   | X   | X   | X  | X  | X  | X  | X  | X  | X  | X  | X  | X  |

**SLEEP** Set the SLEEP bit to '1' to put the device into SPI sleep mode.

When the SLEEP bit = '0', the SPI is in normal mode. The bit is cleared ('0') after a hardware reset (through the  $\overline{\text{RST}}$  pin) or if the  $\overline{\text{WAKEUP}}$  pin is low.

For normal SPI operation, the data entering the SDI pin is transferred into the Shift Register. However, for SPI sleep mode, the Shift Register is bypassed. The data entering into the SDI pin are directly transferred to the SDO pin instead of the Shift Register.

**Broadcast Register.**

The DAC8218 broadcast register can be used to update all eight DAC register channels simultaneously using data bits D15:D2. This write-only register uses address A4:A0 = 07h, and is only available when the SCE bit = '0' (default). If the SCE bit = '1', this register is ignored. Reading this register always returns 0000h.

**Input Data Register for DAC-n, where n = 0 to 7** (default = 0000h).

This register stores the DAC data written to the device when the SCE bit = '1' and is controlled by the correction engine. When the SCE bit = '0' (default), the DAC Data Register stores the DAC data written to the device. When the data are loaded into the corresponding DAC latch, the DAC output changes to the new level defined by the DAC latch. The default value after power-on or reset is 0000h.

**Table 13. DAC-n<sup>(1)</sup> Input Data Register**

| MSB                 |      |      |      |     |     |     |     |     |     |     |     |     |     | LSB |    |
|---------------------|------|------|------|-----|-----|-----|-----|-----|-----|-----|-----|-----|-----|-----|----|
| D15                 | D14  | D13  | D12  | D11 | D10 | D9  | D8  | D7  | D6  | D5  | D4  | D3  | D2  | D1  | D0 |
| DB13 <sup>(2)</sup> | DB12 | DB11 | DB10 | DB9 | DB8 | DB7 | DB6 | DB5 | DB4 | DB3 | DB2 | DB1 | DB0 | X   | X  |

(1) n = 0, 1, 2, 3, 4, 5, 6, or 7.

(2) DB13:DB0 are the DAC data bits.

**Zero Register n, where n = 0 to 7** (default = 0000h).

The Zero Register stores the user-calibration data that are used to eliminate the offset error. The data are 14 bits wide, 1 LSB/step, and the total adjustment is –16384 LSB to +16383 LSB, or  $\pm 50\%$  of full-scale range. The Zero Register uses a twos complement data format.

**Table 14. Zero Register**

| D15 | D14 | D13 | D12 | D11 | D10 | D9 | D8 | D7 | D6 | D5 | D4 | D3 | D2 | D1 | D0 |
|-----|-----|-----|-----|-----|-----|----|----|----|----|----|----|----|----|----|----|
| Z13 | Z12 | Z11 | Z10 | Z9  | Z8  | Z7 | Z6 | Z5 | Z4 | Z3 | Z2 | Z1 | Z0 | X  | X  |

| Z13:Z0—OFFSET BITS | ZERO ADJUSTMENT |
|--------------------|-----------------|
| 1FFFh              | +8191 LSB       |
| 1FFEh              | +8190 LSB       |
| ... ..             | ... ..          |
| 0001h              | +1 LSB          |
| 0000h              | 0 LSB (default) |
| 1FFFh              | –1 LSB          |
| ... ..             | ... ..          |
| 2001h              | –8191 LSB       |
| 2000h              | –8192 LSB       |

**Gain Register n, where n = 0 to 7** (default = 2000h).

The Gain Register stores the user-calibration data that are used to eliminate the gain error. The data are 14 bits wide, 0.0015% FSR/step, and the total adjustment range 0.5 to 1.5. The Gain Register uses a straight binary data format.

**Table 15. Gain Register**

| D15 | D14 | D13 | D12 | D11 | D10 | D9 | D8 | D7 | D6 | D5 | D4 | D3 | D2 | D1 | D0 |
|-----|-----|-----|-----|-----|-----|----|----|----|----|----|----|----|----|----|----|
| G13 | G12 | G11 | G10 | G9  | G8  | G7 | G6 | G5 | G4 | G3 | G2 | G1 | G0 | X  | X  |

  

| G13:G0—GAIN-CODE BITS | GAIN ADJUSTMENT COEFFICIENT |
|-----------------------|-----------------------------|
| 3FFFh                 | 1.499985                    |
| 3FFEh                 | 1.499969                    |
| ... ..                | ... ..                      |
| 2001h                 | 1.000015                    |
| 2000h                 | 1 (default)                 |
| 1FFFh                 | 0.999985                    |
| ... ..                | ... ..                      |
| 0001h                 | 0.500015                    |
| 0000h                 | 0.5                         |

## APPLICATION INFORMATION

### BASIC OPERATION

The DAC8218 is a highly-integrated device with high-performance reference buffers and output buffers, greatly reducing the printed circuit board (PCB) area and production cost. On-chip reference buffers eliminate the need for a negative external reference. [Figure 101](#) shows a basic application for the DAC8218.

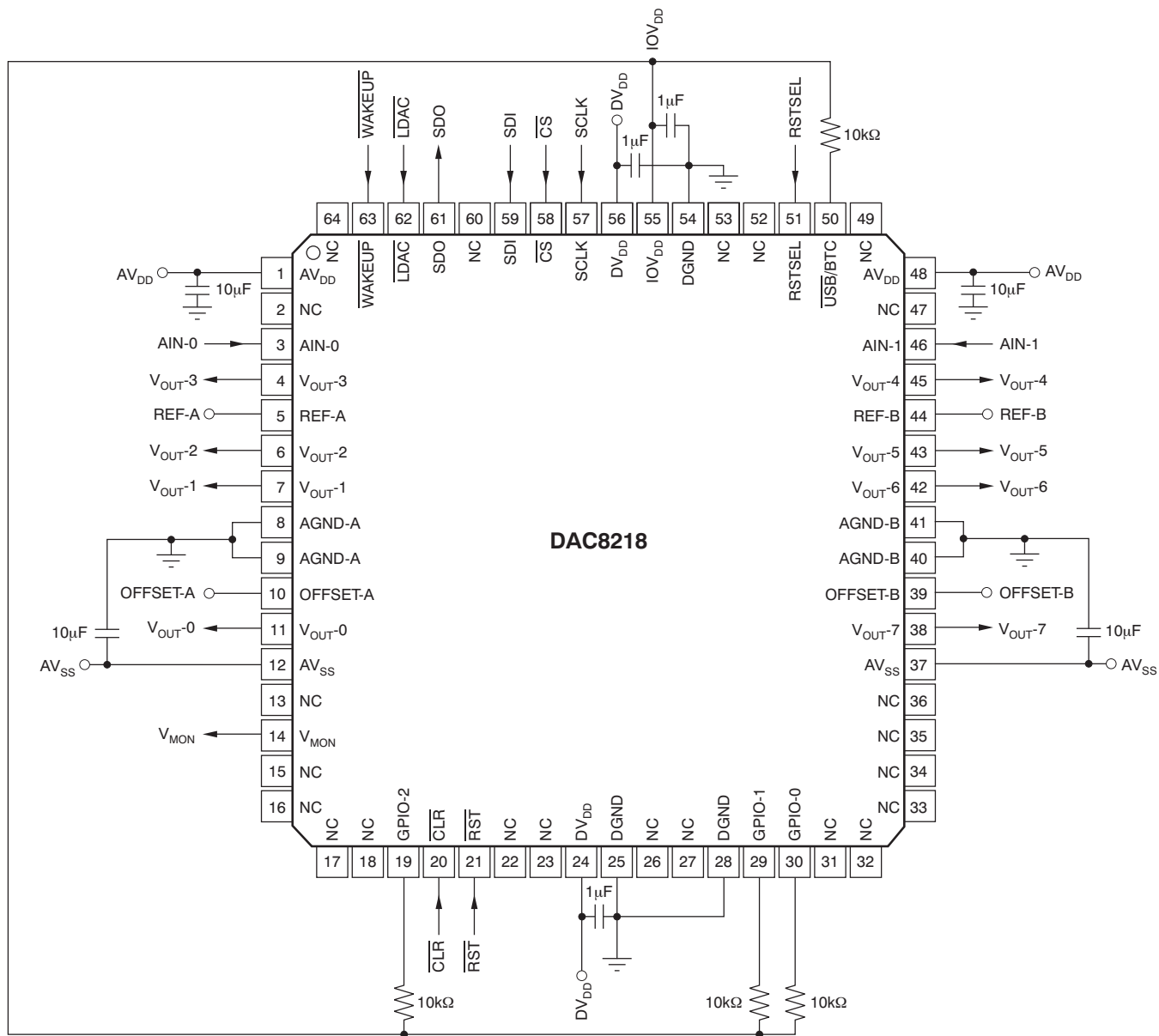

NOTES: AVDD = +15V, AVSS = -15V, DVDD = +5V, IOVDD = +1.8V to +5V, REF-A = +5V, and REF-B = +2.5V.  
The OFFSET-A and OFFSET-B pins must be connected to the AGND pin when used in unipolar operation.

**Figure 101. Basic Application Example**

## PRECISION VOLTAGE REFERENCE SELECTION

To achieve the optimum performance from the DAC8218 over the full operating temperature range, a precision voltage reference must be used. Careful consideration should be given to the selection of a precision voltage reference. The DAC8218 has two reference inputs, REF-A and REF-B. The voltages applied to the reference inputs are used to provide a buffered positive reference for the DAC cores. Therefore, any error in the voltage reference is reflected in the outputs of the device. There are four possible sources of error to consider when choosing a voltage reference for high-accuracy applications: initial accuracy, temperature coefficient of the output voltage, long-term drift, and output voltage noise. Initial accuracy error on the output voltage of an external reference can lead to a full-scale error in the DAC. Therefore, to minimize these errors, a reference with low initial accuracy error specification is preferred. Long-term drift is a measure of how much the reference output voltage drifts over time. A reference with a tight, long-term drift specification ensures that the overall solution remains relatively stable over its entire lifetime. The temperature coefficient of a reference output voltage affects the output drift when the temperature changes. Choose a reference with a tight temperature coefficient specification to reduce the dependence of the DAC output voltage on ambient conditions. In high-accuracy applications, which have a relatively low noise budget, the reference output voltage noise also must be considered. Choosing a reference with as low an output noise voltage as practical for the required system resolution is important. Precision voltage references such as TI's [REF50xx](#) (2V to 5V) and [REF32xx](#) (1.25V to 4V) provide a low-drift, high-accuracy reference voltage.

## POWER-SUPPLY NOISE

The DAC8218 must have ample supply bypassing of  $1\mu\text{F}$  to  $10\mu\text{F}$  in parallel with  $0.1\mu\text{F}$  on each supply, located as close to the package as possible; ideally, immediately next to the device. The  $1\mu\text{F}$  to  $10\mu\text{F}$  capacitors must be the tantalum-bead type. The  $0.1\mu\text{F}$  capacitor must have low effective series resistance (ESR) and low effective series inductance (ESI), such as common ceramic types, which provide a low-impedance path to ground at high frequencies to handle transient currents because of internal logic switching. The power-supply lines must be as large a trace as possible to provide low-impedance paths and reduce the effects of glitches on the power-supply line. Apart from these considerations, the wideband noise on the  $\text{AV}_{\text{DD}}$ ,  $\text{AV}_{\text{SS}}$ ,  $\text{DV}_{\text{DD}}$  and  $\text{IOV}_{\text{DD}}$  supplies should be filtered before feeding to the DAC to obtain the best possible noise performance.

## LAYOUT

Precision analog circuits require careful layout, adequate bypassing, and a clean, well-regulated power supply to obtain the best possible dc and ac performance. Careful consideration of the power-supply and ground-return layout helps to meet the rated performance. DGND is the return path for digital currents and AGND is the power ground for the DAC. For the best ac performance, care should be taken to connect DGND and AGND with very low resistance back to the supply ground. The PCB must be designed so that the analog and digital sections are separated and confined to certain areas of the board. If multiple devices require an AGND-to-DGND connection, the connection is to be made at one point only. The star ground point is established as close as possible to the device.

The power-supply traces must be as large as possible to provide low impedance paths and reduce the effects of glitches on the power-supply line. Fast switching signals must never be run near the reference inputs. It is essential to minimize noise on the reference inputs because it couples through to the DAC output. Avoid crossover of digital and analog signals. Traces on opposite sides of the board must run at right angles to each other. This configuration reduces the effects of feedthrough on the board. A microstrip technique may be considered, but is not always possible with a double-sided board. In this technique, the component side of the board is dedicated to the ground plane, and signal traces are placed on the solder-side.

Each DAC group has a ground pin, AGND-x, which is the ground of the output from the DACs in the group. It must be connected directly to the corresponding reference ground in low-impedance paths to get the best performance. AGND-A must be connected with REFGND-A and AGND-B must be connected with REFGND-B. AGND-A and AGND-B must be tied together and connected to the analog power ground and DGND.

During single-supply operation, the OFFSET-x pins must be connected to AGND-x with a low-impedance path because these pins carry DAC-code-dependent current. Any resistance from OFFSET-x to AGND-x causes a voltage drop by this code-dependent current. Therefore, it is very important to minimize routing resistance to AGND-x or to any ground plane that AGND-x is connected to.

**PACKAGING INFORMATION**

| Orderable Device | Status<br>(1) | Package Type | Package Drawing | Pins | Package Qty | Eco Plan<br>(2) | Lead finish/<br>Ball material<br>(6) | MSL Peak Temp<br>(3) | Op Temp (°C) | Device Marking<br>(4/5) | Samples                 |
|------------------|---------------|--------------|-----------------|------|-------------|-----------------|--------------------------------------|----------------------|--------------|-------------------------|-------------------------|
| DAC8218SPAG      | ACTIVE        | TQFP         | PAG             | 64   | 160         | RoHS & Green    | NIPDAU                               | Level-4-260C-72 HR   | -40 to 105   | DAC8218S                | <a href="#">Samples</a> |
| DAC8218SPAGR     | ACTIVE        | TQFP         | PAG             | 64   | 1500        | RoHS & Green    | NIPDAU                               | Level-4-260C-72 HR   | -40 to 105   | DAC8218S                | <a href="#">Samples</a> |
| DAC8218SRGZR     | ACTIVE        | VQFN         | RGZ             | 48   | 2500        | RoHS & Green    | NIPDAU                               | Level-3-260C-168 HR  | -40 to 105   | DAC8218S                | <a href="#">Samples</a> |
| DAC8218SRGZT     | ACTIVE        | VQFN         | RGZ             | 48   | 250         | RoHS & Green    | NIPDAU                               | Level-3-260C-168 HR  | -40 to 105   | DAC8218S                | <a href="#">Samples</a> |

(1) The marketing status values are defined as follows:

**ACTIVE:** Product device recommended for new designs.

**LIFEBUY:** TI has announced that the device will be discontinued, and a lifetime-buy period is in effect.

**NRND:** Not recommended for new designs. Device is in production to support existing customers, but TI does not recommend using this part in a new design.

**PREVIEW:** Device has been announced but is not in production. Samples may or may not be available.

**OBSELETE:** TI has discontinued the production of the device.

(2) **RoHS:** TI defines "RoHS" to mean semiconductor products that are compliant with the current EU RoHS requirements for all 10 RoHS substances, including the requirement that RoHS substance do not exceed 0.1% by weight in homogeneous materials. Where designed to be soldered at high temperatures, "RoHS" products are suitable for use in specified lead-free processes. TI may reference these types of products as "Pb-Free".

**RoHS Exempt:** TI defines "RoHS Exempt" to mean products that contain lead but are compliant with EU RoHS pursuant to a specific EU RoHS exemption.

**Green:** TI defines "Green" to mean the content of Chlorine (Cl) and Bromine (Br) based flame retardants meet JS709B low halogen requirements of <=1000ppm threshold. Antimony trioxide based flame retardants must also meet the <=1000ppm threshold requirement.

(3) MSL, Peak Temp. - The Moisture Sensitivity Level rating according to the JEDEC industry standard classifications, and peak solder temperature.

(4) There may be additional marking, which relates to the logo, the lot trace code information, or the environmental category on the device.

(5) Multiple Device Markings will be inside parentheses. Only one Device Marking contained in parentheses and separated by a "-" will appear on a device. If a line is indented then it is a continuation of the previous line and the two combined represent the entire Device Marking for that device.

(6) Lead finish/Ball material - Orderable Devices may have multiple material finish options. Finish options are separated by a vertical ruled line. Lead finish/Ball material values may wrap to two lines if the finish value exceeds the maximum column width.

**Important Information and Disclaimer:**The information provided on this page represents TI's knowledge and belief as of the date that it is provided. TI bases its knowledge and belief on information provided by third parties, and makes no representation or warranty as to the accuracy of such information. Efforts are underway to better integrate information from third parties. TI has taken and

continues to take reasonable steps to provide representative and accurate information but may not have conducted destructive testing or chemical analysis on incoming materials and chemicals. TI and TI suppliers consider certain information to be proprietary, and thus CAS numbers and other limited information may not be available for release.

In no event shall TI's liability arising out of such information exceed the total purchase price of the TI part(s) at issue in this document sold by TI to Customer on an annual basis.



**TAPE AND REEL INFORMATION**

**QUADRANT ASSIGNMENTS FOR PIN 1 ORIENTATION IN TAPE**

\*All dimensions are nominal

| Device       | Package Type | Package Drawing | Pins | SPQ  | Reel Diameter (mm) | Reel Width W1 (mm) | A0 (mm) | B0 (mm) | K0 (mm) | P1 (mm) | W (mm) | Pin1 Quadrant |
|--------------|--------------|-----------------|------|------|--------------------|--------------------|---------|---------|---------|---------|--------|---------------|
| DAC8218SRGZR | VQFN         | RGZ             | 48   | 2500 | 330.0              | 16.4               | 7.3     | 7.3     | 1.5     | 12.0    | 16.0   | Q2            |

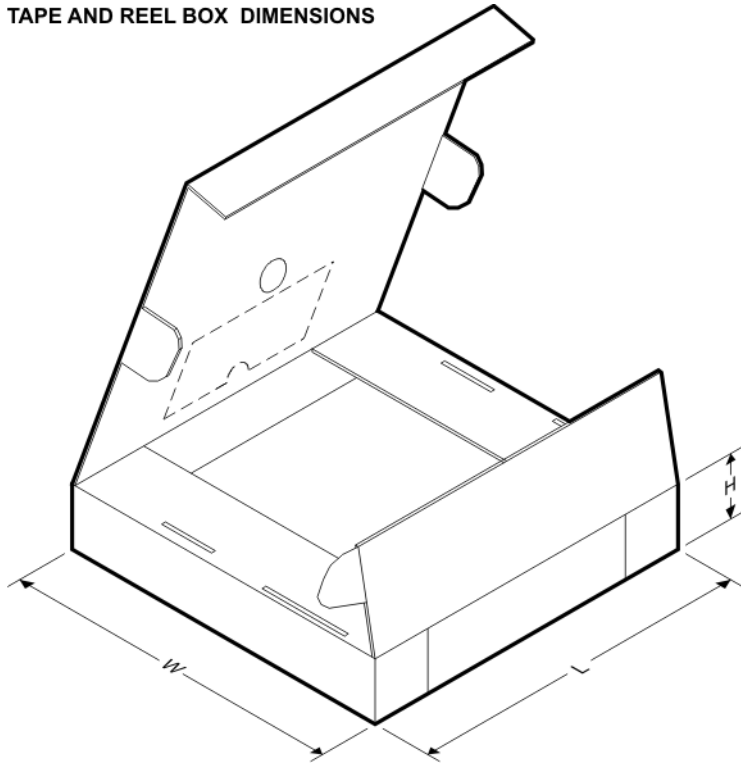
**TAPE AND REEL BOX DIMENSIONS**

\*All dimensions are nominal

| Device       | Package Type | Package Drawing | Pins | SPQ  | Length (mm) | Width (mm) | Height (mm) |
|--------------|--------------|-----------------|------|------|-------------|------------|-------------|
| DAC8218SRGZR | VQFN         | RGZ             | 48   | 2500 | 350.0       | 350.0      | 43.0        |

**TRAY**

Chamfer on Tray corner indicates Pin 1 orientation of packed units.

\*All dimensions are nominal

| Device      | Package Name | Package Type | Pins | SPQ | Unit array matrix | Max temperature (°C) | L (mm) | W (mm) | K0 (µm) | P1 (mm) | CL (mm) | CW (mm) |
|-------------|--------------|--------------|------|-----|-------------------|----------------------|--------|--------|---------|---------|---------|---------|
| DAC8218SPAG | PAG          | TQFP         | 64   | 160 | 8 x 20            | 150                  | 315    | 135.9  | 7620    | 15.2    | 13.1    | 13      |

## GENERIC PACKAGE VIEW

**RGZ 48**

**VQFN - 1 mm max height**

7 x 7, 0.5 mm pitch

PLASTIC QUADFLAT PACK- NO LEAD

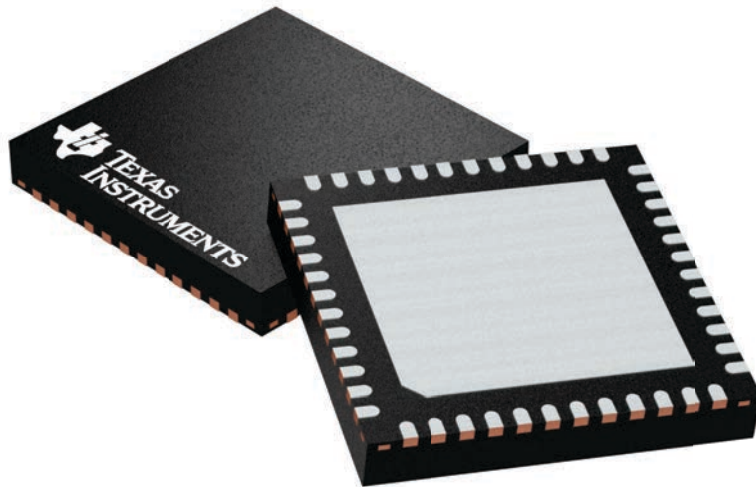

Images above are just a representation of the package family, actual package may vary.  
Refer to the product data sheet for package details.

4224671/A

# RGZ0048D

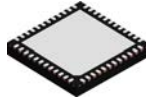

# PACKAGE OUTLINE

## VQFN - 1 mm max height

PLASTIC QUAD FLATPACK - NO LEAD

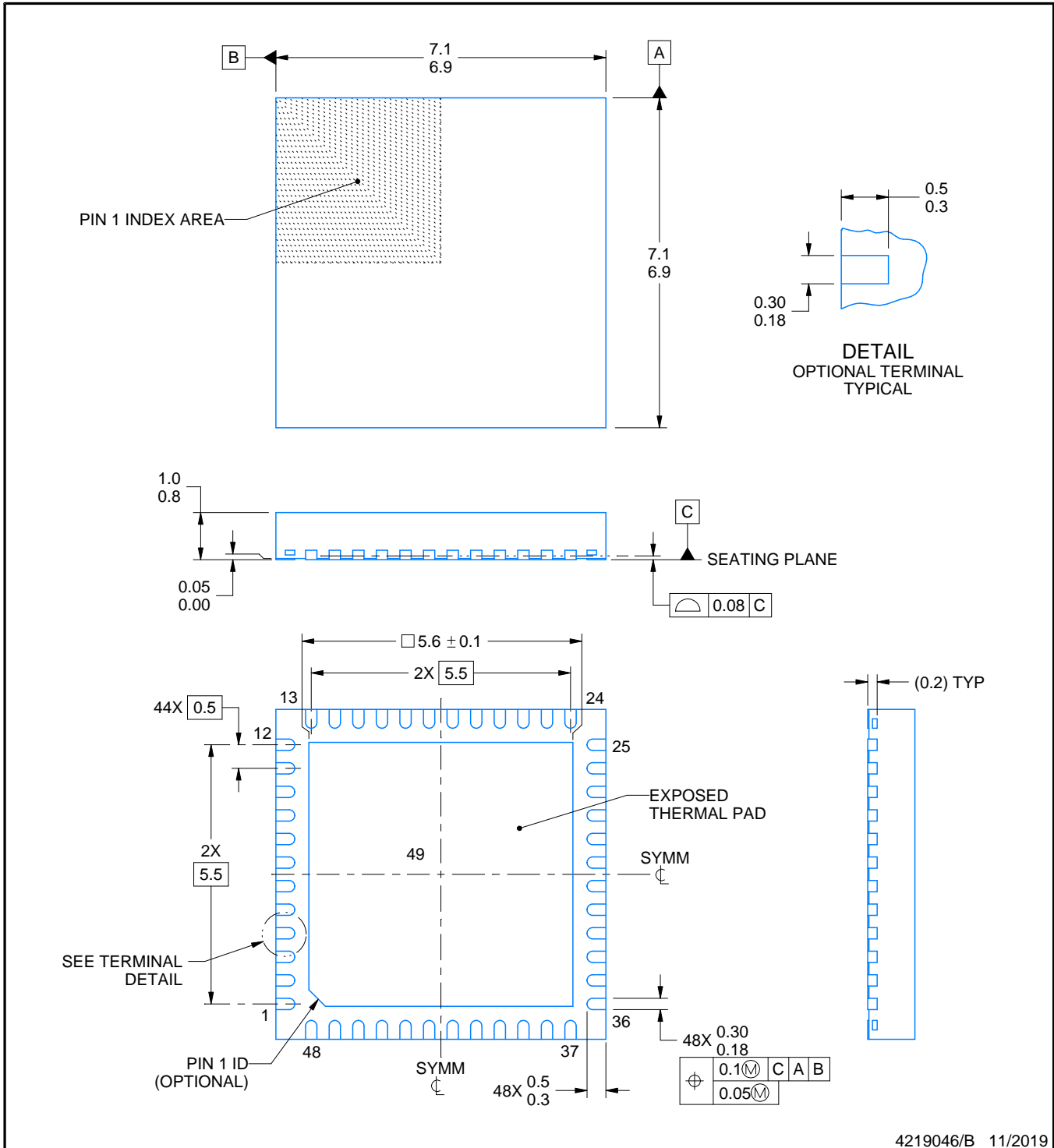

4219046/B 11/2019

**NOTES:**

1. All linear dimensions are in millimeters. Any dimensions in parenthesis are for reference only. Dimensioning and tolerancing per ASME Y14.5M.
2. This drawing is subject to change without notice.
3. The package thermal pad must be soldered to the printed circuit board for thermal and mechanical performance.

# EXAMPLE BOARD LAYOUT

**RGZ0048D**

**VQFN - 1 mm max height**

PLASTIC QUAD FLATPACK - NO LEAD

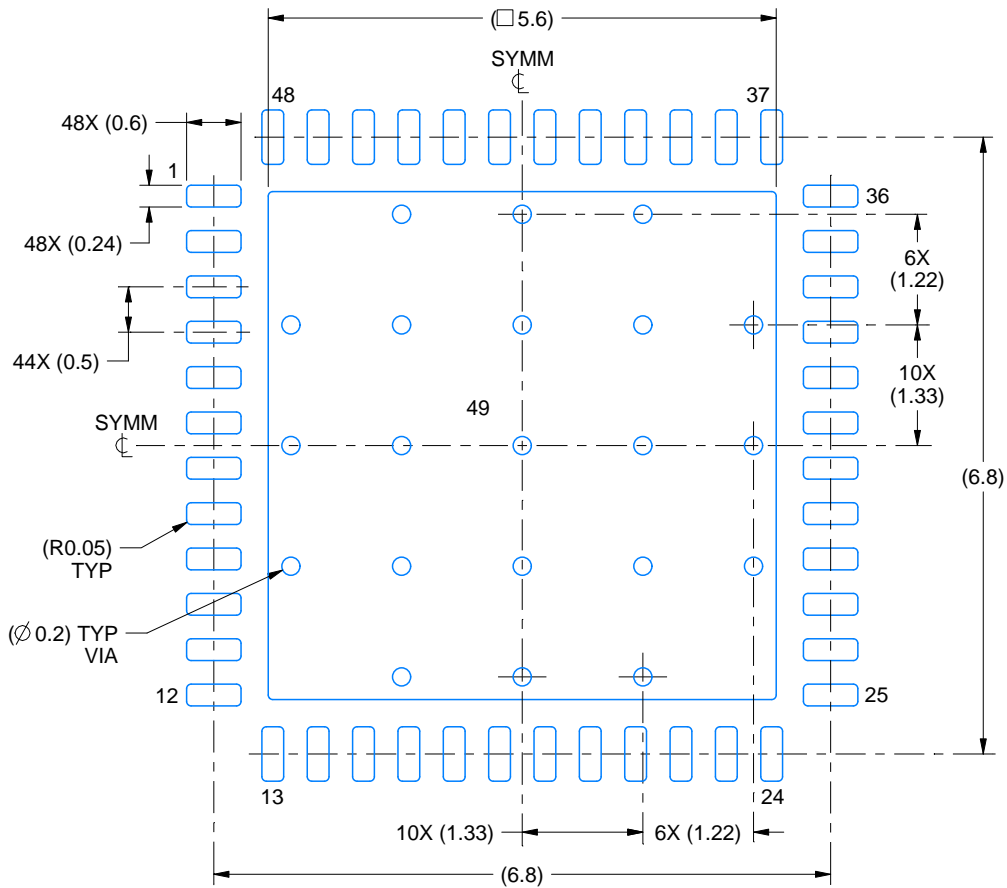

**LAND PATTERN EXAMPLE**  
EXPOSED METAL SHOWN  
SCALE:12X

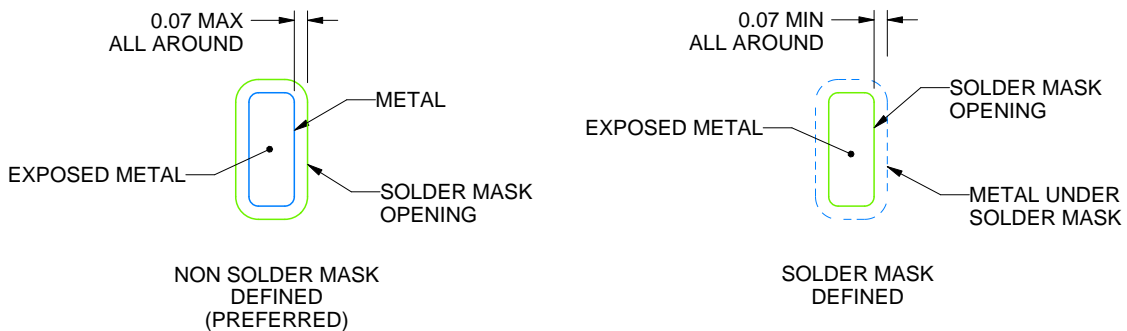

**SOLDER MASK DETAILS**

4219046/B 11/2019

NOTES: (continued)

- This package is designed to be soldered to a thermal pad on the board. For more information, see Texas Instruments literature number SLUA271 ([www.ti.com/lit/sluea271](http://www.ti.com/lit/sluea271)).
- Vias are optional depending on application, refer to device data sheet. If any vias are implemented, refer to their locations shown on this view. It is recommended that vias under paste be filled, plugged or tented.

# EXAMPLE STENCIL DESIGN

RGZ0048D

VQFN - 1 mm max height

PLASTIC QUAD FLATPACK - NO LEAD

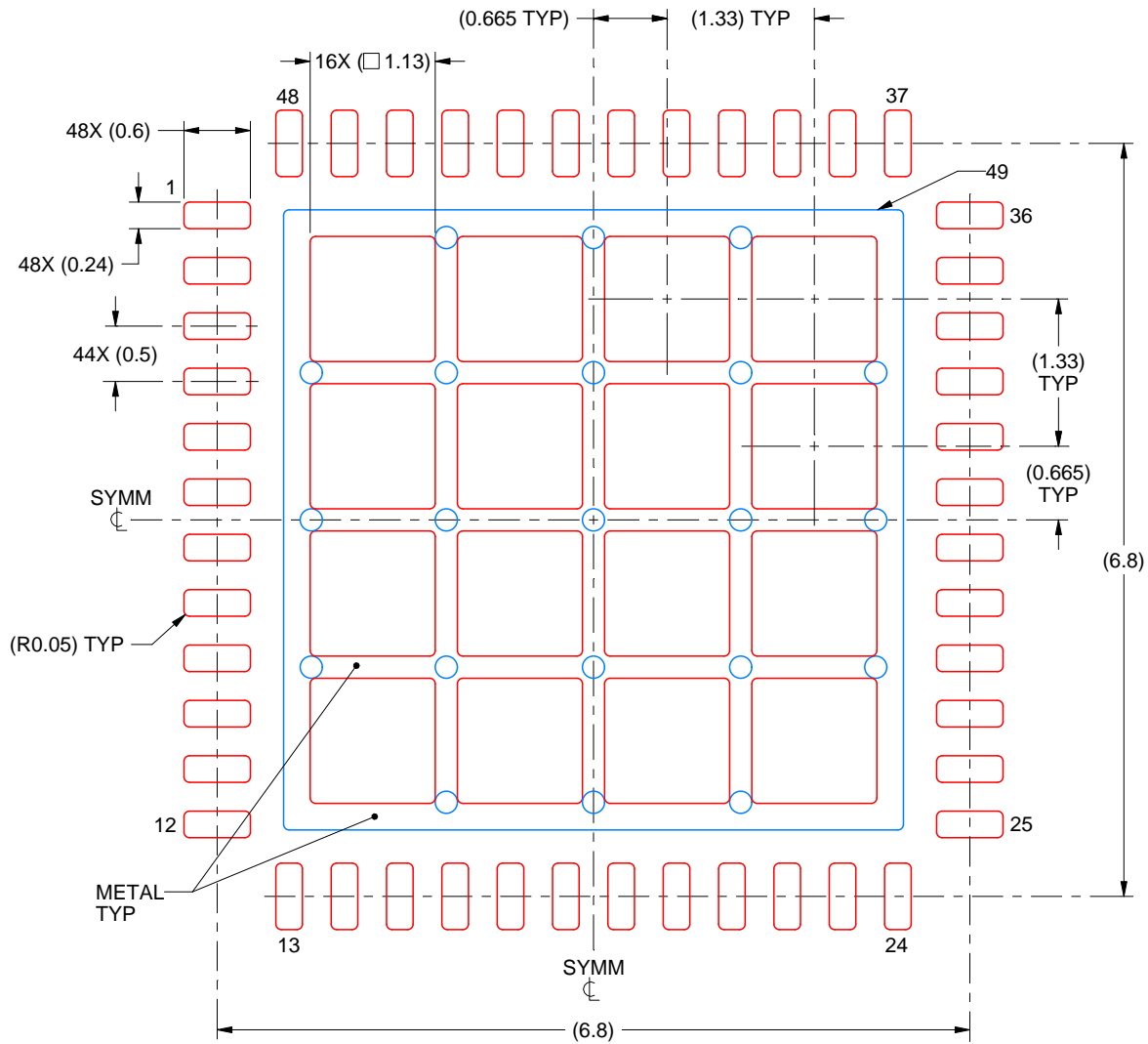

**SOLDER PASTE EXAMPLE**  
 BASED ON 0.125 mm THICK STENCIL

EXPOSED PAD 49  
 66% PRINTED SOLDER COVERAGE BY AREA UNDER PACKAGE  
 SCALE:15X

4219046/B 11/2019

NOTES: (continued)

6. Laser cutting apertures with trapezoidal walls and rounded corners may offer better paste release. IPC-7525 may have alternate design recommendations.

PAG (S-PQFP-G64)

PLASTIC QUAD FLATPACK



- NOTES: A. All linear dimensions are in millimeters.  
 B. This drawing is subject to change without notice.  
 C. Falls within JEDEC MS-026



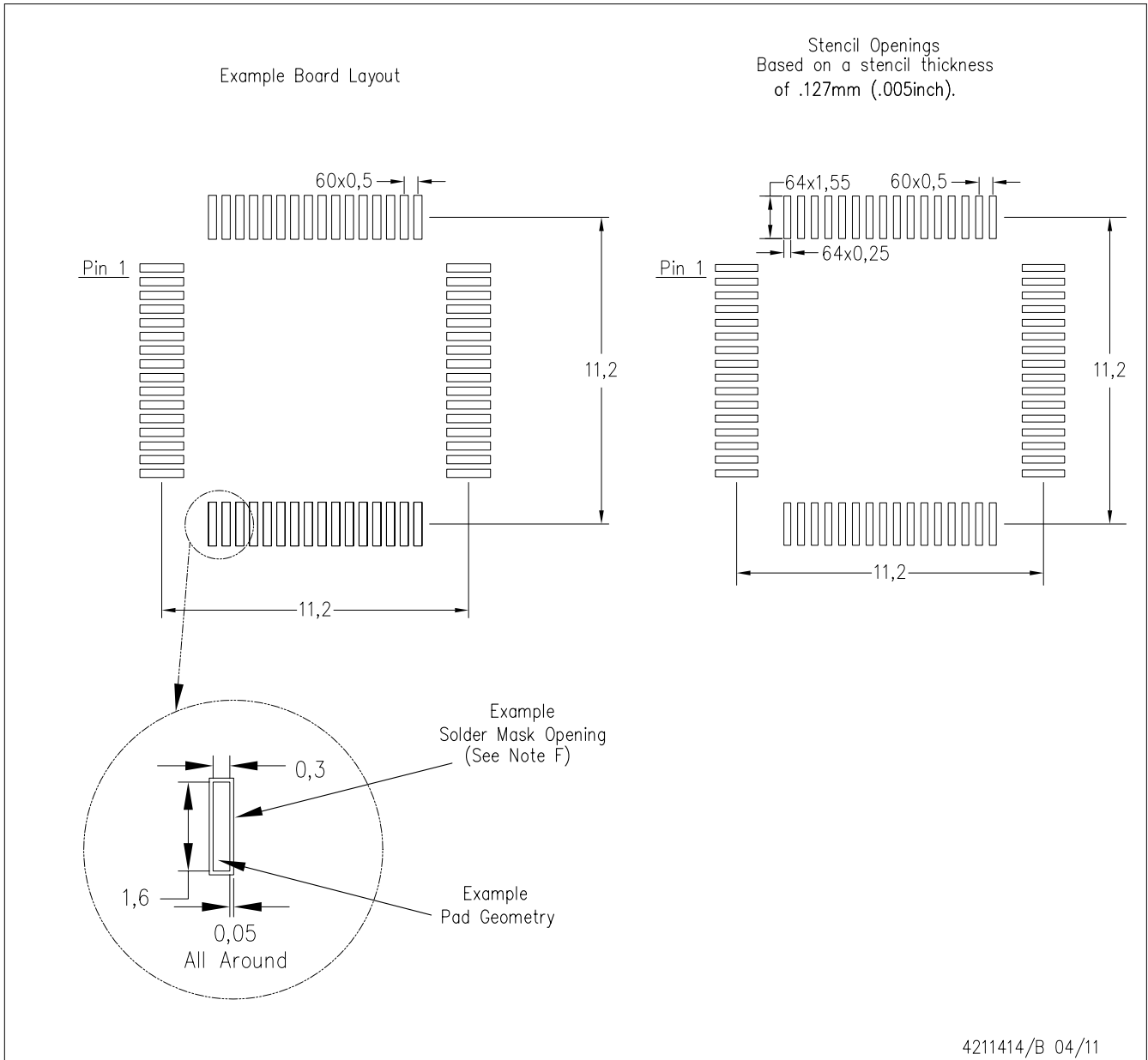

- NOTES:
- A. All linear dimensions are in millimeters.
  - B. This drawing is subject to change without notice.
  - C. Laser cutting apertures with trapezoidal walls and also rounding corners will offer better paste release. Customers should contact their board assembly site for stencil design recommendations. Example stencil design based on a 50% volumetric metal load solder paste. Refer to IPC-7525 for other stencil recommendations.
  - D. Customers should contact their board fabrication site for solder mask tolerances between and around signal pads.

PAG (S-PQFP-G64)

PLASTIC QUAD FLATPACK

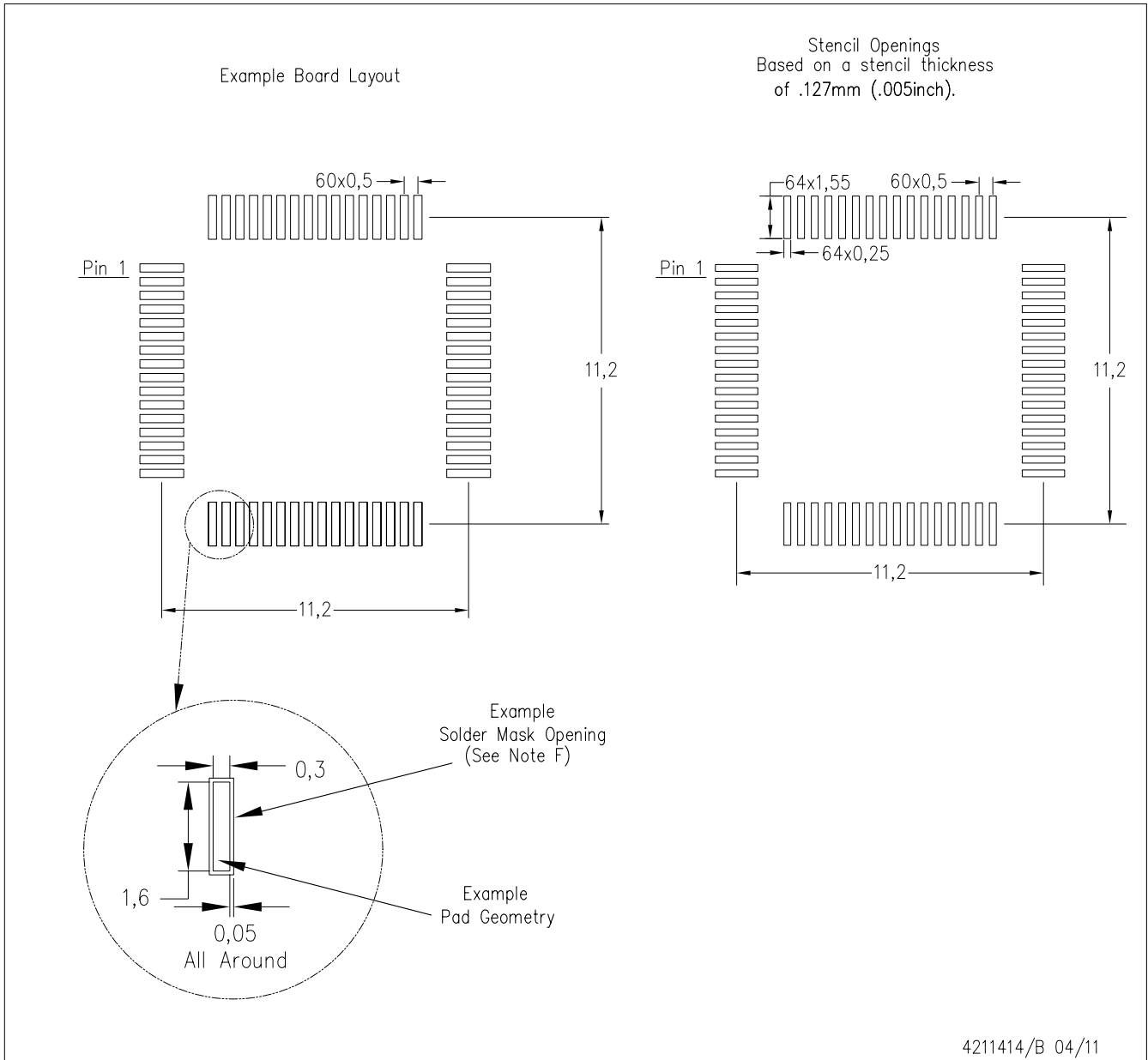

- NOTES:
- A. All linear dimensions are in millimeters.
  - B. This drawing is subject to change without notice.
  - C. Laser cutting apertures with trapezoidal walls and also rounding corners will offer better paste release. Customers should contact their board assembly site for stencil design recommendations. Example stencil design based on a 50% volumetric metal load solder paste. Refer to IPC-7525 for other stencil recommendations.
  - D. Customers should contact their board fabrication site for solder mask tolerances between and around signal pads.

## IMPORTANT NOTICE AND DISCLAIMER

TI PROVIDES TECHNICAL AND RELIABILITY DATA (INCLUDING DATA SHEETS), DESIGN RESOURCES (INCLUDING REFERENCE DESIGNS), APPLICATION OR OTHER DESIGN ADVICE, WEB TOOLS, SAFETY INFORMATION, AND OTHER RESOURCES "AS IS" AND WITH ALL FAULTS, AND DISCLAIMS ALL WARRANTIES, EXPRESS AND IMPLIED, INCLUDING WITHOUT LIMITATION ANY IMPLIED WARRANTIES OF MERCHANTABILITY, FITNESS FOR A PARTICULAR PURPOSE OR NON-INFRINGEMENT OF THIRD PARTY INTELLECTUAL PROPERTY RIGHTS.

These resources are intended for skilled developers designing with TI products. You are solely responsible for (1) selecting the appropriate TI products for your application, (2) designing, validating and testing your application, and (3) ensuring your application meets applicable standards, and any other safety, security, regulatory or other requirements.

These resources are subject to change without notice. TI grants you permission to use these resources only for development of an application that uses the TI products described in the resource. Other reproduction and display of these resources is prohibited. No license is granted to any other TI intellectual property right or to any third party intellectual property right. TI disclaims responsibility for, and you will fully indemnify TI and its representatives against, any claims, damages, costs, losses, and liabilities arising out of your use of these resources.

TI's products are provided subject to [TI's Terms of Sale](#) or other applicable terms available either on [ti.com](http://ti.com) or provided in conjunction with such TI products. TI's provision of these resources does not expand or otherwise alter TI's applicable warranties or warranty disclaimers for TI products.

TI objects to and rejects any additional or different terms you may have proposed.

Mailing Address: Texas Instruments, Post Office Box 655303, Dallas, Texas 75265  
Copyright © 2022, Texas Instruments Incorporated