

Notes:
No. of Positions 64 with three key; Other positions with one key

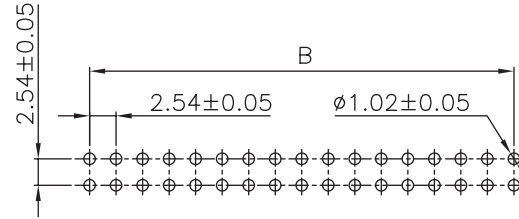

PCB LAYOUT - COMPONENT VIEW

TECHNICAL CHARACTERISTICS

MATERIAL
INSULATOR: PBT
FLAMABILITY RATING: UL94-V0
COLOR: BLACK
CONTACT MATERIAL: COPPER ALLOY
CONTACT TYPE: STAMPED
CONTACT PLATING: GOLD
QUALITY CLASS: 3 AS PER CECC 75 301-802
PITCH: 2.54 MM

ENVIRONMENTAL
OPERATING TEMPERATURE: -40 UP TO 125°C
COMPLIANCE: LEAD FREE AND ROHS

ELECTRICAL
CURRENT RATING: 3 A MAX
WORKING VOLTAGE: 250 VAC
INSULATOR RESISTANCE: >1000 MOHM
DIELECTRIC WITHSTANDING VOLTAGE: 500 VAC/MN
CONTACT RESISTANCE: 20 MOHM MAX

STANDARD
CERTIFIED: E323964

SOLDERING
JEDEC LEAD FREE WAVE SOLDERING PROCESS

PACKAGING
TRAY

DIMENSION

No. of Positions	Dim A	Dim B	No. of Positions	Dim A	Dim B
6	27.12	5.08	26	52.52	30.48
8	29.66	7.62	30	57.60	35.56
10	32.20	10.16	34	62.68	40.64
12	34.74	12.70	40	70.30	48.26
14	37.28	15.24	50	83.00	60.96
16	39.82	17.78	60	95.70	73.66
20	44.90	22.86	64	100.78	78.74
24	49.98	27.94			

Holes left and right appear from polarity 20

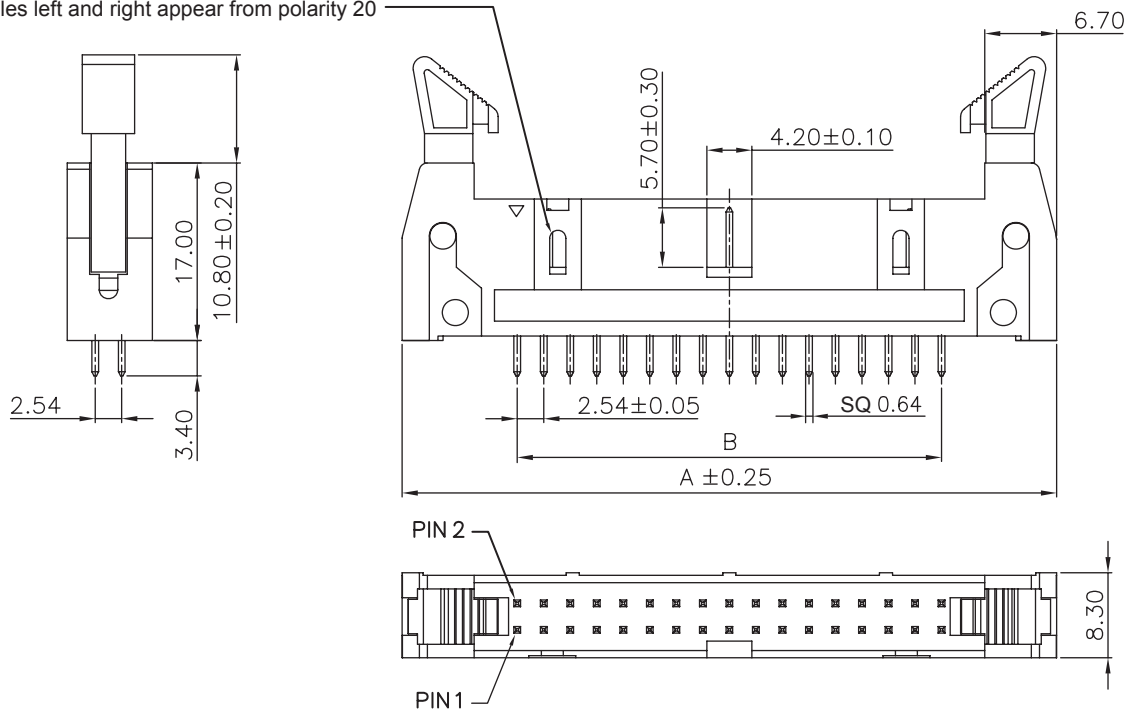

RoHS Compliant	
N	08-DEC-16
M	24-MAR-16
L	20-OCT-15
K	27-JAN-14
J	19-MAR-13
I	22-FEB-13
H	19-DEC-12
REV	DATE

DRAWING	AK
TPK	AK
NOTES	AK
DWG UPDATE	QL
NOTES	AR
OVERWALL DIM	QL
REMOVE UL MARK	QL
FILE	BY

PROJECTION:
APPROVAL: GMo

GENERAL TOLERANCE
.X = +/- 0.2
.XX = +/- 0.15
UNIT: MM
SCALE:
SHEET: 1/3
DRAW: MIKE

	DESCRIPTION: 2.54MM MALE BOX HEADER WITH LONG LEVER	SIZE A4
WERI PART NO: 612 0xx 228 21		

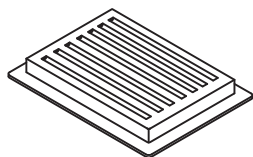
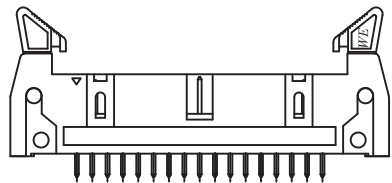

TRAY

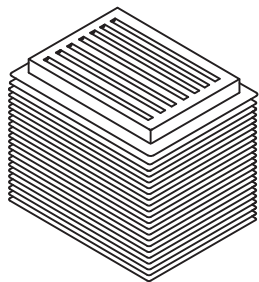

15 TRAYS

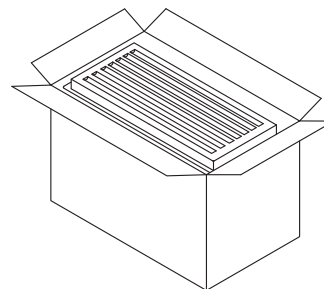
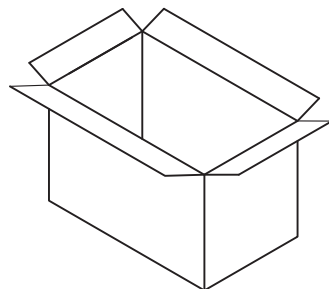

CARTON

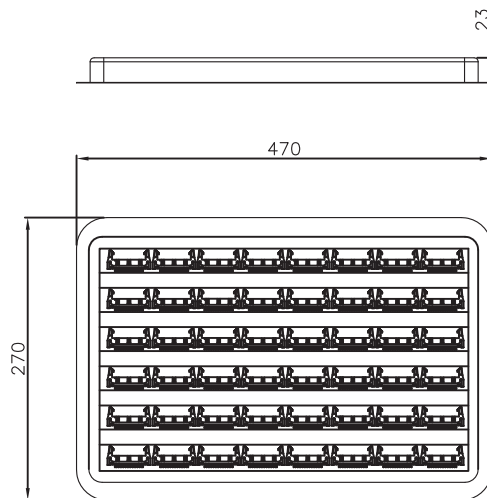
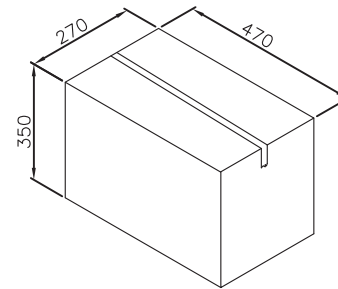

TRAY LAYOUT

Note:

1.Dimension:

Tray Size:470(L)x270(W)x23(H) (mm)

Carton Size:470(L)x270(W)x350(H) (mm)

2.Quantity:

CIRCUITS	PCS/TRAY	TRAYS/CARTON	Q'TY
6	180	15	2700
8	168	15	2520
10	156	15	2340
14	132	15	1980
16	120	15	1800
20	108	15	1620
24-26	96	15	1440
30	84	15	1260
34-40	72	15	1080
50	60	15	900
60-64	48	15	720

RoHS Compliant

F			
E			
D			
C			
B			
A			
REV	DATE	FILE	BY

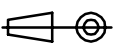
PROJECTION:

GENERAL TOLERANCE
 .X = +/- 0.2
 .XX = +/- 0.15



APPROVAL: GMo

UNIT: MM
 SCALE:
 SHEET: 2/3
 DRAW: AK

DESCRIPTION: 2.54MM MALE BOX HEADER WITH LONG LEVER
 WERI PART NO: 612 0xx 228 21

SIZE
A4

