

SMF5.0AT1G Series



OBSOLETE/EOL

DATE [June/30/2018](#) **PCN/ECN#** [LFPCN41246](#)
REPLACED BY [SMF Series](#)



Maximum Ratings and Thermal Characteristics

Rating	Symbol	Value	Unit
Maximum Ppk Dissipation (PW=10/1000 μ s) (Note 1) SMF5.0A – SMF58A	P_{PK}	200	W
Maximum Ppk Dissipation @ TA = 25°C, (PW=8/20 μ s) (Note 2)	P_{PK}	1000	W
DC Power Dissipation @ TA = 25°C (Note 3)	PD	385	mW
Derate Above 25°C		4.0	mW/°C
Thermal Resistance from Junction-to-Ambient (Note 3)	$R_{\theta JA}$	325	°C/W
Operating and Storage Temperature Range	T_J, T_{stg}	-55 to +150	°C

Stresses exceeding Maximum Ratings may damage the device. Maximum Ratings are stress ratings only. Functional operation above the Recommended Operating Conditions is not implied. Extended exposure to stresses above the Recommended Operating Conditions may affect device reliability.

1. Non-repetitive current pulse at TA = 25°C, per waveform of Figure 2.
2. Non-repetitive current pulse at TA = 25°C, per waveform of Figure 3.
3. Mounted with recommended minimum pad size, DC board FR-4.

Description

The SMF5.0AT1G Series is designed to protect voltage sensitive components from high voltage, high energy transients. Excellent clamping capability, high surge capability, low zener impedance and fast response time. Because of its small size, it is ideal for use in cellular phones, portable devices, business machines, power supplies and many other industrial/consumer applications.

Features

- Stand-off Voltage: 5 – 58 Volts
- Peak Power – 200 Watts @ 1 ms (SMF5.0A – SMF58A)
- Low Leakage
- Response Time is Typically < 1 ns
- ESD Rating of Class 3 (> 16 kV) per Human Body Model
- ESD Rating of Level 4 (8 kV Contact Discharge) per IEC61000-4-2
- EFT (Electrical Fast Transients) Rating of 40 A per IEC61000-4-4
- Low Profile – Maximum Height of 1.0 mm
- Small Footprint – Footprint Area of 8.45 mm²
- Supplied in 8 mm Tape and Reel – 3,000 Units per Reel
- Cathode Indicated by Polarity Band
- Lead Orientation in Tape: Cathode Lead to Sprocket Holes
- These Devices are Pb-Free and are RoHS Compliant

Functional Diagram

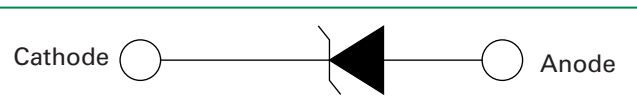

Additional Information



Datasheet



Resources



Samples

I-V Curve Characteristics ($T_A = 25^\circ\text{C}$ unless otherwise noted, $V_F = 3.5\text{ V Max.}$ @ I_F (Note 4) = 12 A)

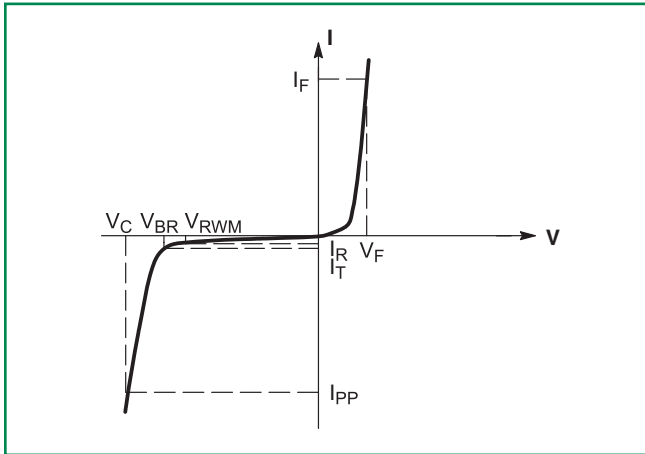

Symbol	Parameter
I_{PP}	Maximum Reverse Peak Pulse Current
V_C	Clamping Voltage @ I_{PP}
V_{RWM}	Working Peak Reverse Voltage
I_R	Maximum Reverse Leakage Current @ V_{RWM}
V_{BR}	Breakdown Voltage @ I_T
I_T	Test Current
I_F	Forward Current
V_F	Forward Voltage @ I_F

4. 1/2 sine wave (or equivalent square wave), PW = 8.3 ms, duty cycle = 4 pulses per minute maximum.

Ratings and Characteristic Curves

Figure 1. Pulse Rating Curve

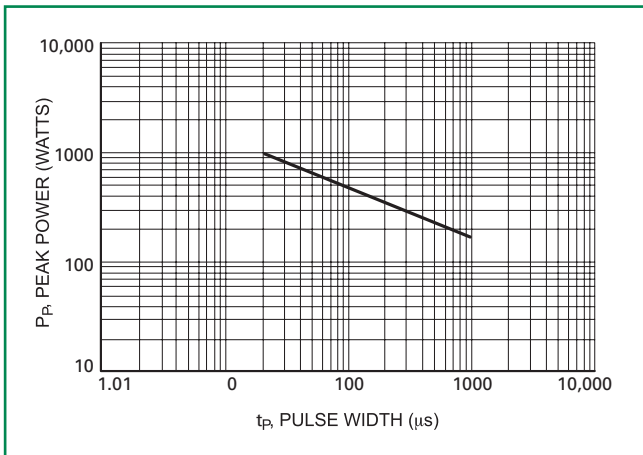

Figure 2. 10 X 1000 μs Pulse Waveform

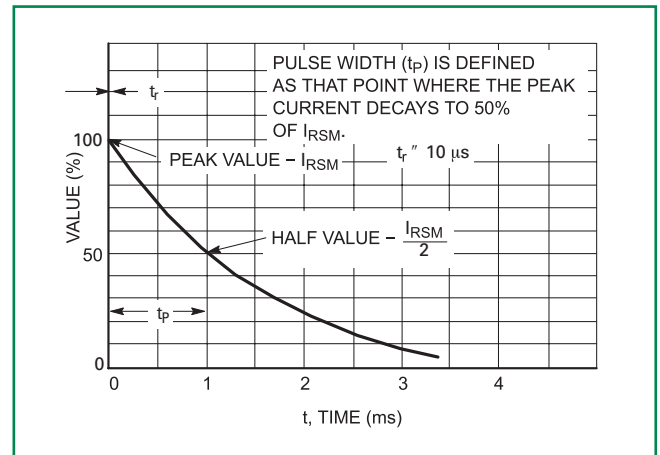

Figure 3. 8 X 20 μs Pulse Waveform

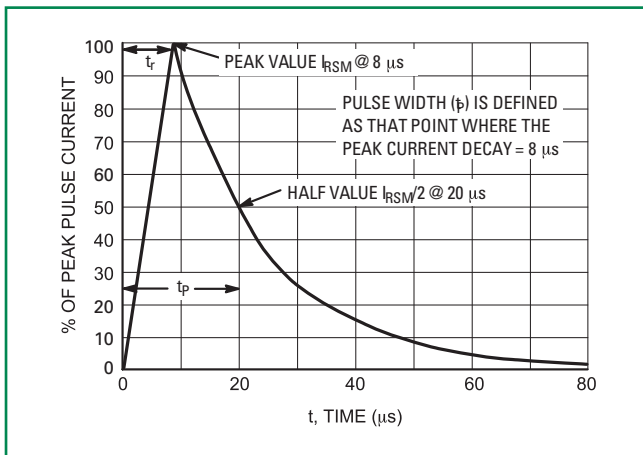

Figure 4. Pulse Derating Curve

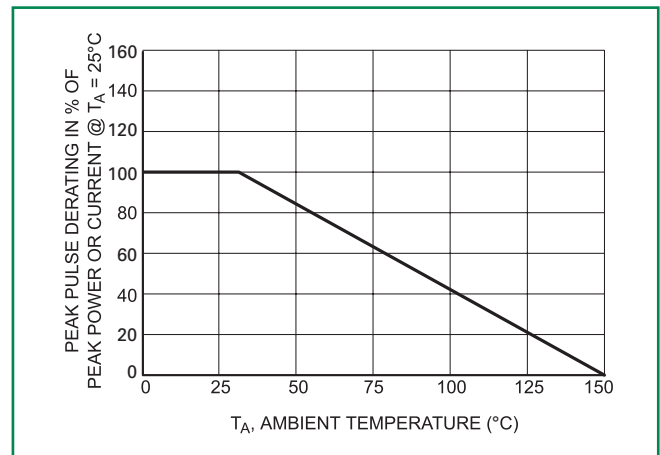

Figure 5. Typical Derating Factor for Duty Cycle

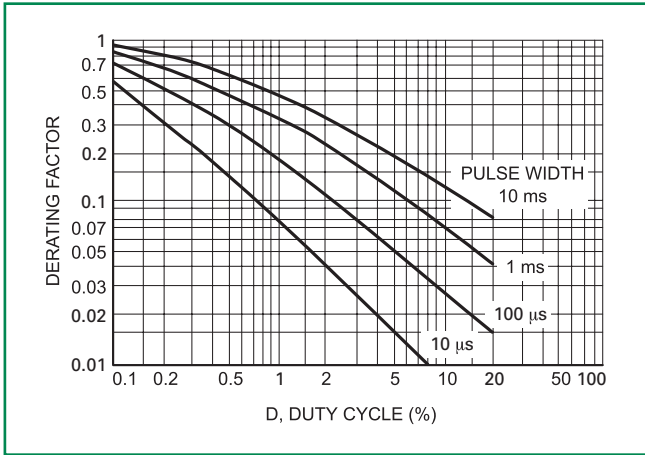

Figure 6. Steady State Power Derating

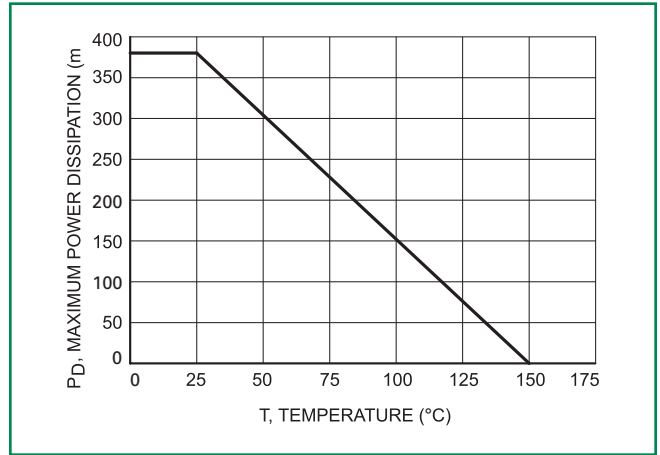

Figure 7. Forward Voltage

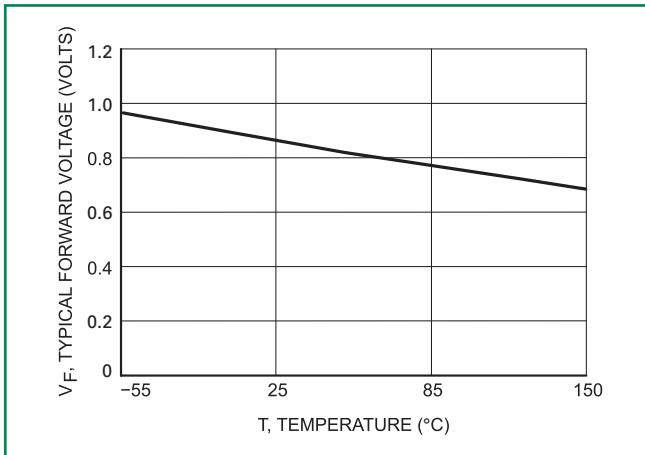
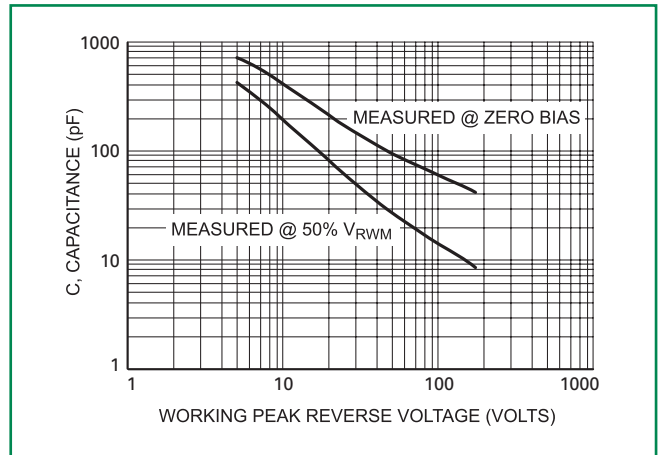

Figure 8. Capacitance vs. Working Peak Reverse Voltage



Electrical Characteristics ($T_L = 30^\circ\text{C}$ unless otherwise noted, $V_F = 1.25$ Volts @ 200 mA)

Device	Device Marking	V_{RWM}	$I_R @ V_{RWM}$	$V_{BR} @ I_T$ (V) (Note 6)			$@ I_T$	$I_R @ V_{RWM}$	$V_C(\text{Max})$	$I_{PP}(\text{Max})$ (A)
		V	μA	Min	Nom	Max	mA	(μA)	(V)	(Note 7)
SMF5.0AG	KE	5	400	6.4	6.7	7.0	10	400	9.2	21.7
SMF6.0AG	KG	6	400	6.67	7.02	7.37	10	400	10.3	19.4
SMF6.5AG	KK	6.5	250	7.22	7.60	7.98	10	250	11.2	17.9
SMF7.0AG	KM	7	100	7.78	8.19	8.6	10	100	12	16.7
SMF7.5AG	KP	7.5	50	8.33	8.77	9.21	1	50	12.9	15.5
SMF8.0AG	KR	8	25	8.89	9.36	9.83	1	25	13.6	14.7
SMF9.0AG	KV	9	5	10	10.55	11.1	1	5	15.4	13.0
SMF10AG	KX	10	2.5	11.1	11.7	12.3	1	2.5	17	11.8
SMF11AG	KZ	11	2.5	12.2	12.85	13.5	1	2.5	18.2	11.0
SMF12AG	LE	12	2.5	13.3	14	14.7	1	2.5	19.9	10.1
SMF13AG	LG	13	1	14.4	15.15	15.9	1	1	21.5	9.3
SMF14AG	LK	14	1	15.6	16.4	17.2	1	1	23.2	8.6
SMF15AG	LM	15	1	16.7	17.6	18.5	1	1	24.4	8.2
SMF18AG	LT	18	1	20	21	22.1	1	1	29.2	6.8
SMF20AG	LV	20	1	22.2	23.35	24.5	1	1	32.4	6.2
SMF22AG	LX	22	1	24.4	25.6	26.9	1	1	35.5	5.6
SMF24AG	LZ	24	1	26.7	28.1	29.5	1	1	38.9	5.1
SMF26AG	ME	26	1	28.9	30.4	31.9	1	1	42.1	4.8
SMF28AG	MG	28	1	31.1	32.8	34.4	1	1	45.4	4.4
SMF30AG	MK	30	1	33.3	35.1	36.8	1	1	48.4	4.1
SMF33AG	MM	33	1	36.7	38.7	40.6	1	1	53.3	3.8
SMF36AG	MP	36	1	40	42.1	44.2	1	1	58.1	3.4
SMF48AG	MX	48	1	53.3	56.1	58.9	1	1	77.4	2.6
SMF51AG	MZ	51	1	56.7	59.7	62.7	1	1	82.4	2.4
SMF58AG	NG	58	1	64.4	67.8	71.2	1	1	93.6	2.1

5. A transient suppressor is normally selected according to the Working Peak Reverse Voltage (V_{RWM}) which should be equal to or greater than the DC or continuous peak operating voltage level.

6. V_{BR} measured at pulse test current I_T at ambient temperature of 25°C .

7. Surge current waveform per Figure 2 and derate per Figure 3.

Dimensions

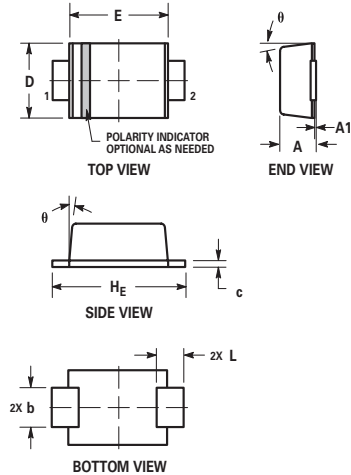

Dim	Inches			Millimeters		
	Min	Nom	Max	Min	Nom	Max
A	0.035	0.037	0.039	0.90	0.95	0.98
A1	0.000	0.002	0.004	0.00	0.05	0.10
b	0.028	0.035	0.043	0.70	0.90	1.10
c	0.004	0.006	0.008	0.10	0.15	0.20
D	0.059	0.065	0.071	1.50	1.65	1.80
E	0.098	0.106	0.114	2.50	2.70	2.90
L	0.022	0.030	0.037	0.55	0.75	0.95
H _E	0.134	0.142	0.150	3.40	3.60	3.80
θ	0°	-	8°	0°	-	8°

- NOTES:
1. DIMENSIONING AND TOLERANCING PER ANSI Y14.5M, 1982.
 2. CONTROLLING DIMENSION: MILLIMETER.
 3. DIMENSIONS A AND B DO NOT INCLUDE MOLD FLASH.
 4. DIMENSIONS D AND J ARE TO BE MEASURED ON FLAT SECTION OF THE LEAD: BETWEEN 0.10 AND 0.25 MM FROM THE LEAD TIP.

Part Marking System

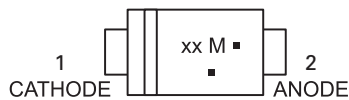

- xx = Device Code (Refer to page 3)
 - M = Date Code
 - = Pb-Free Package
- (Note: Microdot may be in either location)

Soldering Footprint

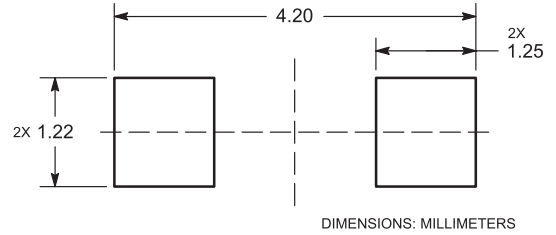

ORDERING INFORMATION

Device	Package	Shipping†
SMFxxxAT1G	SOD-123FL (Pb-Free)	3,000 / Tape & Reel

Flow/Wave Soldering (Solder Dipping)

Peak Temperature :	260°C Device Meets MSL 1 Requirements
---------------------------	---

Physical Specifications

Case	Void-free, transfer-molded, thermosetting plastic Epoxy Meets UL 94 V-0
Lead Finish	100% Matte Sn (Tin)
Mounting Position	Any

Disclaimer Notice - Information furnished is believed to be accurate and reliable. However, users should independently evaluate the suitability of and test each product selected for their own applications. Littelfuse products are not designed for, and may not be used in, all applications. Read complete Disclaimer Notice at: www.littelfuse.com/disclaimer-electronics.