

74LVC1G175-Q100

Single D-type flip-flop with reset; positive-edge trigger

Rev. 3 — 3 October 2019

Product data sheet

1. General description

The 74LVC1G175-Q100 is a low-power, low-voltage single positive edge triggered D-type flip-flop with individual data (D) input, clock (CP) input, master reset (\overline{MR}) input, and Q output. The master reset (\overline{MR}) is an asynchronous active LOW input and operates independently of the clock input. Information on the data input is transferred to the Q output on the LOW-to-HIGH transition of the clock pulse. The D input must be stable one set-up time prior to the LOW-to-HIGH clock transition for predictable operation. The inputs can be driven from either 3.3 V or 5 V devices. This feature allows the use of this device in a mixed 3.3 V and 5 V environment. This device is fully specified for partial power-down applications using I_{OFF} . The I_{OFF} circuitry disables the output, preventing the damaging backflow current through the device when it is powered down. Schmitt trigger action at all inputs makes the circuit highly tolerant of slower input rise and fall times.

This product has been qualified to the Automotive Electronics Council (AEC) standard Q100 (Grade 1) and is suitable for use in automotive applications.

2. Features and benefits

- Automotive product qualification in accordance with AEC-Q100 (Grade 1)
 - Specified from -40 °C to +85 °C and from -40 °C to +125 °C
- Wide supply voltage range from 1.65 V to 5.5 V
- 5 V tolerant inputs for interfacing with 5 V logic
- High noise immunity
- Complies with JEDEC standard:
 - JESD8-7 (1.65 V to 1.95 V)
 - JESD8-5 (2.3 V to 2.7 V)
 - JESD8B/JESD36 (2.7 V to 3.6 V).
- ± 24 mA output drive ($V_{CC} = 3.0$ V)
- CMOS low power consumption
- Latch-up performance exceeds 250 mA
- Direct interface with TTL levels
- Inputs accept voltages up to 5 V
- ESD protection:
 - MIL-STD-883, method 3015 exceeds 2000 V
 - HBM JESD22-A114F exceeds 2000 V
 - MM JESD22-A115-A exceeds 200 V (C = 200 pf, R = 0 Ω)

3. Ordering information

Table 1. Ordering information

Type number	Package			
	Temperature range	Name	Description	Version
74LVC1G175GW-Q100	-40 °C to +125 °C	SC-88	plastic surface-mounted package; 6 leads	SOT363
74LVC1G175GV-Q100	-40 °C to +125 °C	SC-74	plastic surface-mounted package (SC-74; TSOP6); 6 leads	SOT457

4. Marking

Table 2. Marking

Type number	Marking code [1]
74LVC1G175GW-Q100	YT
74LVC1G175GV-Q100	V75

[1] The pin 1 indicator is located on the lower left corner of the device, below the marking code.

5. Functional diagram

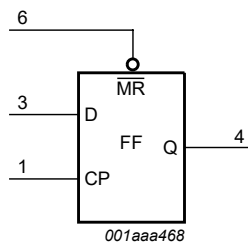

Fig. 1. Logic symbol

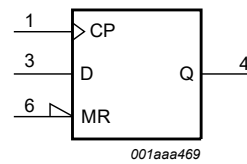

Fig. 2. IEC logic symbol

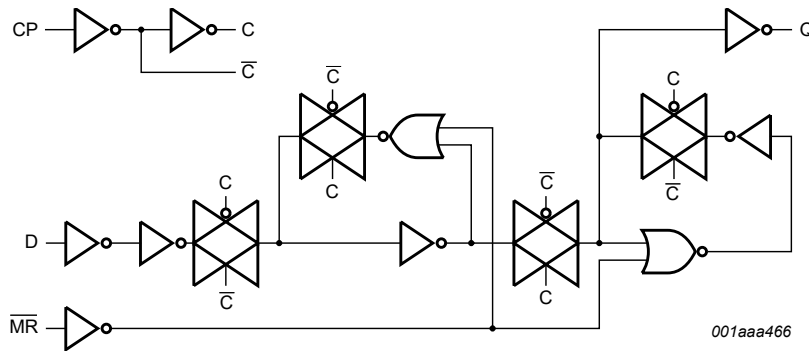

Fig. 3. Logic diagram

6. Pinning information

6.1. Pinning

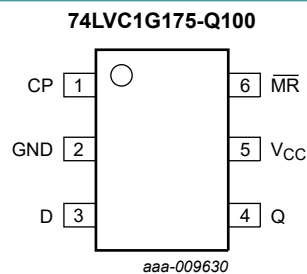

Fig. 4. Pin configuration SOT363 (SC-88) and SOT457 (SC-74)

6.2. Pin description

Table 3. Pin description

Symbol	Pin	Description
CP	1	clock input (LOW-to-HIGH, edge-triggered)
GND	2	ground (0 V)
D	3	data input
Q	4	output Q
V _{CC}	5	supply voltage
$\overline{\text{MR}}$	6	master reset input (active LOW)

7. Functional description

Table 4. Function table

H = HIGH voltage level; h = HIGH voltage level one set-up time prior to the LOW-to-HIGH CP transition;
 L = LOW voltage level; l = LOW voltage level one set-up time prior to the LOW-to-HIGH CP transition;
 ↑ = LOW-to-HIGH CP transition; X = don't care.

Operating mode	Input			Output
	$\overline{\text{MR}}$	CP	D	Q
Reset (clear)	L	X	X	L
Load '1'	H	↑	h	H
Load '0'	H	↑	l	L

8. Limiting values

Table 5. Limiting values

In accordance with the Absolute Maximum Rating System (IEC 60134). Voltages are referenced to GND (ground = 0 V).

Symbol	Parameter	Conditions	Min	Max	Unit	
V _{CC}	supply voltage		-0.5	+6.5	V	
I _{IK}	input clamping current	V _I < 0 V	-50	-	mA	
V _I	input voltage	[1]	-0.5	+6.5	V	
I _{OK}	output clamping current	V _O > V _{CC} or V _O < 0 V	-	±50	mA	
V _O	output voltage	Active mode	[1]	-0.5	V _{CC} + 0.5	V
		Power-down mode; V _{CC} = 0 V	[1]	-0.5	+6.5	V
I _O	output current	V _O = 0 V to V _{CC}	-	±50	mA	
I _{CC}	supply current		-	100	mA	
I _{GND}	ground current		-100	-	mA	
P _{tot}	total power dissipation	T _{amb} = -40 °C to +125 °C	[2]	-	250	mW
T _{stg}	storage temperature		-65	+150	°C	

[1] The input and output voltage ratings may be exceeded if the input and output current ratings are observed.

[2] For SOT363 (TSSOP6) packages: P_{tot} derates linearly with 3.7 mW/K above 83 °C.

For SOT457 (TSOP6) packages: P_{tot} derates linearly with 4.1 mW/K above 89 °C.

9. Recommended operating conditions

Table 6. Recommended operating conditions

Symbol	Parameter	Conditions	Min	Typ	Max	Unit
V_{CC}	supply voltage		1.65	-	5.5	V
V_I	input voltage		0	-	5.5	V
V_O	output voltage	Active mode	0	-	V_{CC}	V
		Power-down mode; $V_{CC} = 0$ V	0	-	5.5	V
T_{amb}	ambient temperature		-40	-	+125	°C
$\Delta t/\Delta V$	input transition rise and fall rate	$V_{CC} = 1.65$ V to 2.7 V	-	-	20	ns/V
		$V_{CC} = 2.7$ V to 5.5 V	-	-	10	ns/V

10. Static characteristics

Table 7. Static characteristics

At recommended operating conditions. Voltages are referenced to GND (ground = 0 V).

Symbol	Parameter	Conditions	Min	Typ [1]	Max	Unit
$T_{amb} = -40$ °C to +85 °C						
V_{IH}	HIGH-level input voltage	$V_{CC} = 1.65$ V to 1.95 V	$0.65 \times V_{CC}$	-	-	V
		$V_{CC} = 2.3$ V to 2.7 V	1.7	-	-	V
		$V_{CC} = 2.7$ V to 3.6 V	2.0	-	-	V
		$V_{CC} = 4.5$ V to 5.5 V	$0.7 \times V_{CC}$	-	-	V
V_{IL}	LOW-level input voltage	$V_{CC} = 1.65$ V to 1.95 V	-	-	$0.35 \times V_{CC}$	V
		$V_{CC} = 2.3$ V to 2.7 V	-	-	0.7	V
		$V_{CC} = 2.7$ V to 3.6 V	-	-	0.8	V
		$V_{CC} = 4.5$ V to 5.5 V	-	-	$0.3 \times V_{CC}$	V
V_{OH}	HIGH-level output voltage	$V_I = V_{IH}$ or V_{IL}				
		$I_O = -100$ μ A; $V_{CC} = 1.65$ V to 5.5 V	$V_{CC} - 0.1$	-	-	V
		$I_O = -4$ mA; $V_{CC} = 1.65$ V	1.2	1.54	-	V
		$I_O = -8$ mA; $V_{CC} = 2.3$ V	1.9	2.15	-	V
		$I_O = -12$ mA; $V_{CC} = 2.7$ V	2.2	2.50	-	V
		$I_O = -24$ mA; $V_{CC} = 3.0$ V	2.3	2.62	-	V
V_{OL}	LOW-level output voltage	$V_I = V_{IH}$ or V_{IL}				
		$I_O = 100$ μ A; $V_{CC} = 1.65$ V to 5.5 V	-	-	0.10	V
		$I_O = 4$ mA; $V_{CC} = 1.65$ V	-	0.07	0.45	V
		$I_O = 8$ mA; $V_{CC} = 2.3$ V	-	0.12	0.30	V
		$I_O = 12$ mA; $V_{CC} = 2.7$ V	-	0.17	0.40	V
		$I_O = 24$ mA; $V_{CC} = 3.0$ V	-	0.33	0.55	V
		$I_O = 32$ mA; $V_{CC} = 4.5$ V	-	0.39	0.55	V

Single D-type flip-flop with reset; positive-edge trigger

Symbol	Parameter	Conditions	Min	Typ [1]	Max	Unit
I_I	input leakage current	$V_{CC} = 0\text{ V to }5.5\text{ V}$; $V_I = 5.5\text{ V or GND}$ [2]	-	± 0.1	± 1	μA
I_{OFF}	power-off leakage current	$V_{CC} = 0\text{ V}$; V_I or $V_O = 5.5\text{ V}$	-	± 0.1	± 2	μA
I_{CC}	supply current	$V_{CC} = 1.65\text{ V to }5.5\text{ V}$; $I_O = 0\text{ A}$; $V_I = 5.5\text{ V or GND}$	-	0.1	4	μA
ΔI_{CC}	additional supply current	$V_{CC} = 2.3\text{ V to }5.5\text{ V}$; $V_I = V_{CC} - 0.6\text{ V}$; $I_O = 0\text{ A}$ [2]	-	5	500	μA
C_I	input capacitance	$V_{CC} = 3.3\text{ V}$; $V_I = \text{GND to }V_{CC}$	-	2.5	-	pF
$T_{amb} = -40\text{ }^\circ\text{C to }+125\text{ }^\circ\text{C}$						
V_{IH}	HIGH-level input voltage	$V_{CC} = 1.65\text{ V to }1.95\text{ V}$	$0.65 \times V_{CC}$	-	-	V
		$V_{CC} = 2.3\text{ V to }2.7\text{ V}$	1.7	-	-	V
		$V_{CC} = 2.7\text{ V to }3.6\text{ V}$	2.0	-	-	V
		$V_{CC} = 4.5\text{ V to }5.5\text{ V}$	$0.7 \times V_{CC}$	-	-	V
V_{IL}	LOW-level input voltage	$V_{CC} = 1.65\text{ V to }1.95\text{ V}$	-	-	$0.35 \times V_{CC}$	V
		$V_{CC} = 2.3\text{ V to }2.7\text{ V}$	-	-	0.7	V
		$V_{CC} = 2.7\text{ V to }3.6\text{ V}$	-	-	0.8	V
		$V_{CC} = 4.5\text{ V to }5.5\text{ V}$	-	-	$0.3 \times V_{CC}$	V
V_{OH}	HIGH-level output voltage	$V_I = V_{IH}$ or V_{IL}				
		$I_O = -100\text{ }\mu\text{A}$; $V_{CC} = 1.65\text{ V to }5.5\text{ V}$	$V_{CC} - 0.1$	-	-	V
		$I_O = -4\text{ mA}$; $V_{CC} = 1.65\text{ V}$	0.95	-	-	V
		$I_O = -8\text{ mA}$; $V_{CC} = 2.3\text{ V}$	1.7	-	-	V
		$I_O = -12\text{ mA}$; $V_{CC} = 2.7\text{ V}$	1.9	-	-	V
		$I_O = -24\text{ mA}$; $V_{CC} = 3.0\text{ V}$	2.0	-	-	V
V_{OL}	LOW-level output voltage	$V_I = V_{IH}$ or V_{IL}				
		$I_O = 100\text{ }\mu\text{A}$; $V_{CC} = 1.65\text{ V to }5.5\text{ V}$	-	-	0.10	V
		$I_O = 4\text{ mA}$; $V_{CC} = 1.65\text{ V}$	-	-	0.70	V
		$I_O = 8\text{ mA}$; $V_{CC} = 2.3\text{ V}$	-	-	0.45	V
		$I_O = 12\text{ mA}$; $V_{CC} = 2.7\text{ V}$	-	-	0.60	V
		$I_O = 24\text{ mA}$; $V_{CC} = 3.0\text{ V}$	-	-	0.80	V
V_{OL}	LOW-level output voltage	$I_O = 32\text{ mA}$; $V_{CC} = 4.5\text{ V}$	-	-	0.80	V
		$V_{CC} = 0\text{ V to }5.5\text{ V}$; $V_I = 5.5\text{ V or GND}$	-	-	± 1	μA
		$V_{CC} = 0\text{ V}$; V_I or $V_O = 5.5\text{ V}$	-	-	± 2	μA
		$V_{CC} = 1.65\text{ V to }5.5\text{ V}$; $I_O = 0\text{ A}$; $V_I = 5.5\text{ V or GND}$	-	-	4	μA
		$V_{CC} = 2.3\text{ V to }5.5\text{ V}$; $V_I = V_{CC} - 0.6\text{ V}$; $I_O = 0\text{ A}$	-	-	500	μA

[1] All typical values are measured at $T_{amb} = 25\text{ }^\circ\text{C}$.

[2] These typical values are measured at $V_{CC} = 3.3\text{ V}$.

11. Dynamic characteristics

Table 8. Dynamic characteristics

Voltages are referenced to GND (ground = 0 V); for test circuit see Fig. 7.

Symbol	Parameter	Conditions	-40 °C to +85 °C			-40 °C to +125 °C		Unit
			Min	Typ [1]	Max	Min	Max	
t_{pd}	propagation delay	CP to Q; see Fig. 5 [2]						
		$V_{CC} = 1.65 \text{ V to } 1.95 \text{ V}$	1.5	4.9	13.4	1.5	17	ns
		$V_{CC} = 2.3 \text{ V to } 2.7 \text{ V}$	1.0	3.1	7.1	1.0	9.0	ns
		$V_{CC} = 2.7 \text{ V}$	1.0	3.2	7.1	1.0	9.0	ns
		$V_{CC} = 3.0 \text{ V to } 3.6 \text{ V}$	1.0	3.1	5.7	0.5	7.5	ns
		$V_{CC} = 4.5 \text{ V to } 5.5 \text{ V}$	1.0	2.2	4.0	0.5	5.5	ns
		MR to Q; see Fig. 6						
		$V_{CC} = 1.65 \text{ V to } 1.95 \text{ V}$	1.5	4.3	12.9	1.5	17	ns
		$V_{CC} = 2.3 \text{ V to } 2.7 \text{ V}$	1.0	2.8	7.0	1.0	9.0	ns
		$V_{CC} = 2.7 \text{ V}$	1.0	3.0	7.0	1.0	9.0	ns
		$V_{CC} = 3.0 \text{ V to } 3.6 \text{ V}$	1.0	2.5	5.8	0.5	7.5	ns
		$V_{CC} = 4.5 \text{ V to } 5.5 \text{ V}$	1.0	2.0	4.1	0.5	5.5	ns
t_w	pulse width	CP HIGH or LOW; see Fig. 5						
		$V_{CC} = 1.65 \text{ V to } 1.95 \text{ V}$	6.2	-	-	6.2	-	ns
		$V_{CC} = 2.3 \text{ V to } 2.7 \text{ V}$	2.7	-	-	2.7	-	ns
		$V_{CC} = 2.7 \text{ V}$	2.7	-	-	2.7	-	ns
		$V_{CC} = 3.0 \text{ V to } 3.6 \text{ V}$	2.7	1.3	-	2.7	-	ns
		$V_{CC} = 4.5 \text{ V to } 5.5 \text{ V}$	2.0	-	-	2.0	-	ns
		MR LOW; see Fig. 6						
		$V_{CC} = 1.65 \text{ V to } 1.95 \text{ V}$	6.2	-	-	6.2	-	ns
		$V_{CC} = 2.3 \text{ V to } 2.7 \text{ V}$	2.7	-	-	2.7	-	ns
		$V_{CC} = 2.7 \text{ V}$	2.7	-	-	2.7	-	ns
		$V_{CC} = 3.0 \text{ V to } 3.6 \text{ V}$	2.7	1.6	-	2.7	-	ns
		$V_{CC} = 4.5 \text{ V to } 5.5 \text{ V}$	2.0	-	-	2.0	-	ns
t_{rec}	recovery time	MR; see Fig. 6						
		$V_{CC} = 1.65 \text{ V to } 1.95 \text{ V}$	1.9	-	-	1.9	-	ns
		$V_{CC} = 2.3 \text{ V to } 2.7 \text{ V}$	1.4	-	-	1.4	-	ns
		$V_{CC} = 2.7 \text{ V}$	1.3	-	-	1.3	-	ns
		$V_{CC} = 3.0 \text{ V to } 3.6 \text{ V}$	1.2	0.4	-	1.2	-	ns
		$V_{CC} = 4.5 \text{ V to } 5.5 \text{ V}$	1.0	-	-	1.0	-	ns
t_{su}	set-up time	D to CP; see Fig. 5						
		$V_{CC} = 1.65 \text{ V to } 1.95 \text{ V}$	2.9	-	-	2.9	-	ns
		$V_{CC} = 2.3 \text{ V to } 2.7 \text{ V}$	1.7	-	-	1.7	-	ns
		$V_{CC} = 2.7 \text{ V}$	1.7	-	-	1.7	-	ns
		$V_{CC} = 3.0 \text{ V to } 3.6 \text{ V}$	1.3	0.5	-	1.3	-	ns
		$V_{CC} = 4.5 \text{ V to } 5.5 \text{ V}$	1.1	-	-	1.1	-	ns

Single D-type flip-flop with reset; positive-edge trigger

Symbol	Parameter	Conditions	-40 °C to +85 °C			-40 °C to +125 °C		Unit
			Min	Typ [1]	Max	Min	Max	
t _h	hold time	D to CP; see Fig. 5						
		V _{CC} = 1.65 V to 1.95 V	0.0	-	-	0.0	-	ns
		V _{CC} = 2.3 V to 2.7 V	0.3	-	-	0.3	-	ns
		V _{CC} = 2.7 V	0.5	-	-	0.5	-	ns
		V _{CC} = 3.0 V to 3.6 V	1.2	0.2	-	1.2	-	ns
		V _{CC} = 4.5 V to 5.5 V	0.5	-	-	0.5	-	ns
f _{max}	maximum frequency	CP; see Fig. 5						
		V _{CC} = 1.65 V to 1.95 V	80	125	-	80	-	MHz
		V _{CC} = 2.3 V to 2.7 V	175	-	-	175	-	MHz
		V _{CC} = 2.7 V	175	-	-	175	-	MHz
		V _{CC} = 3.0 V to 3.6 V	175	300	-	175	-	MHz
		V _{CC} = 4.5 V to 5.5 V	200	-	-	200	-	MHz
C _{PD}	power dissipation capacitance	V _I = GND to V _{CC} ; V _{CC} = 3.3 V [3]	-	14	-	-	-	pF

[1] Typical values are measured at T_{amb} = 25 °C and V_{CC} = 1.8 V, 2.5 V, 2.7 V, 3.3 V and 5.0 V respectively.

[2] t_{pd} is the same as t_{PLH} and t_{PHL}.

[3] C_{PD} is used to determine the dynamic power dissipation (P_D in μW).

$$P_D = C_{PD} \times V_{CC}^2 \times f_i \times N + \sum(C_L \times V_{CC}^2 \times f_o) \text{ where:}$$

f_i = input frequency in MHz;

f_o = output frequency in MHz;

C_L = output load capacitance in pF;

V_{CC} = supply voltage in Volts;

N = number of inputs switching;

∑(C_L × V_{CC}² × f_o) = sum of the outputs.

11.1. Waveforms

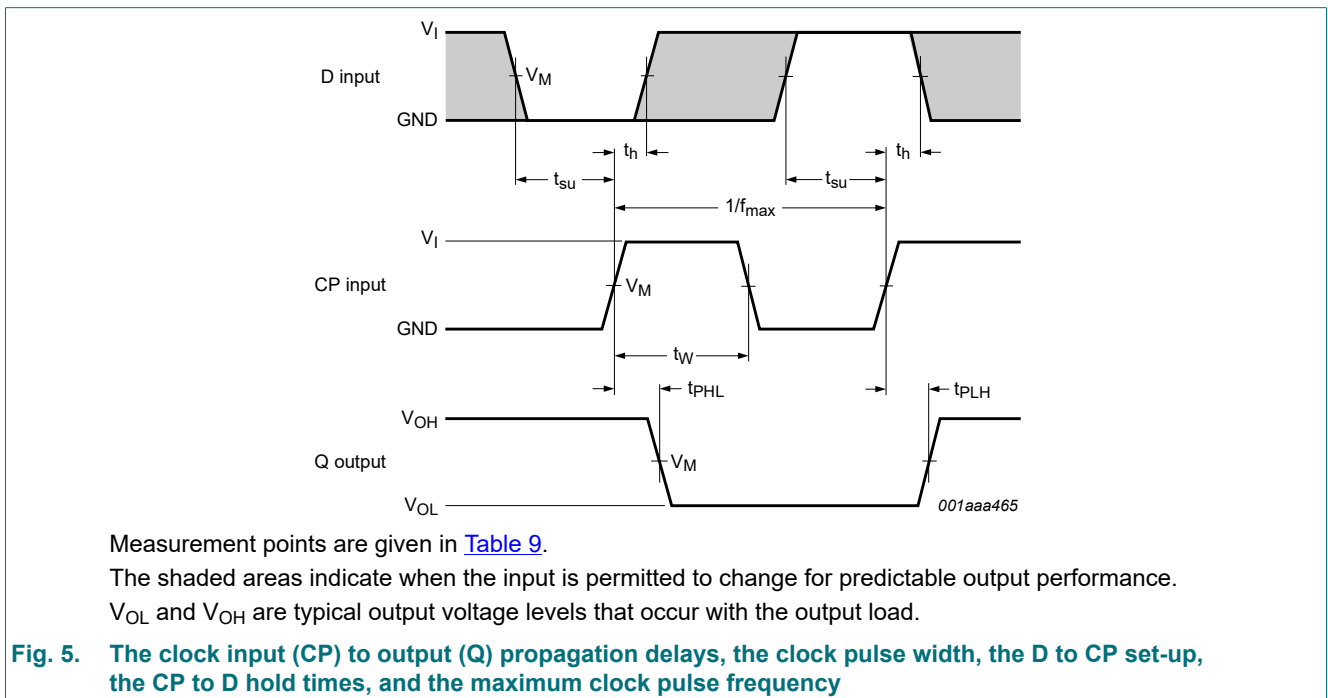

Measurement points are given in Table 9.

The shaded areas indicate when the input is permitted to change for predictable output performance.

V_{OL} and V_{OH} are typical output voltage levels that occur with the output load.

Fig. 5. The clock input (CP) to output (Q) propagation delays, the clock pulse width, the D to CP set-up, the CP to D hold times, and the maximum clock pulse frequency

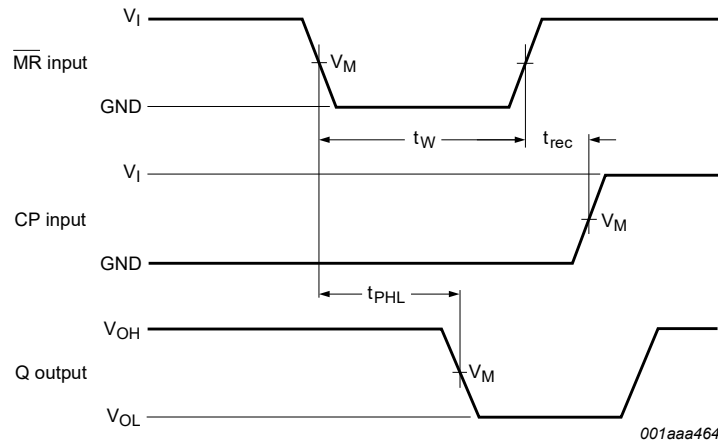

Measurement points are given in [Table 9](#).

V_{OL} and V_{OH} are typical output voltage levels that occur with the output load.

Fig. 6. The master reset (\overline{MR}) input to output (Q) propagation delays, the master reset pulse width, and the \overline{MR} to CP recovery time

Table 9. Measurement points

Supply voltage	Input	Output
V_{CC}	V_M	V_M
1.65 V to 1.95 V	$0.5 \times V_{CC}$	$0.5 \times V_{CC}$
2.3 V to 2.7 V	$0.5 \times V_{CC}$	$0.5 \times V_{CC}$
2.7 V	1.5 V	1.5 V
3.0 V to 3.6 V	1.5 V	1.5 V
4.5 V to 5.5 V	$0.5 \times V_{CC}$	$0.5 \times V_{CC}$

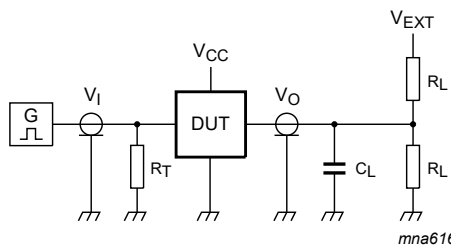

Test data is given in [Table 10](#).

Definitions for test circuit:

R_L = Load resistance.

C_L = Load capacitance including jig and probe capacitance.

R_T = Termination resistance should be equal to the output impedance Z_o of the pulse generator.

V_{EXT} = External voltage for measuring switching times.

Fig. 7. Test circuit for measuring switching times

Table 10. Test data

Supply voltage	Input		Load		V_{EXT}
	V_I	$t_r = t_f$	C_L	R_L	t_{PLH}, t_{PHL}
1.65 V to 1.95 V	V_{CC}	≤ 2.0 ns	30 pF	1 k Ω	open
2.3 V to 2.7 V	V_{CC}	≤ 2.0 ns	30 pF	500 Ω	open
2.7 V	2.7 V	≤ 2.5 ns	50 pF	500 Ω	open
3.0 V to 3.6 V	2.7 V	≤ 2.5 ns	50 pF	500 Ω	open
4.5 V to 5.5 V	V_{CC}	≤ 2.5 ns	50 pF	500 Ω	open

12. Package outline

Plastic surface-mounted package; 6 leads

SOT363

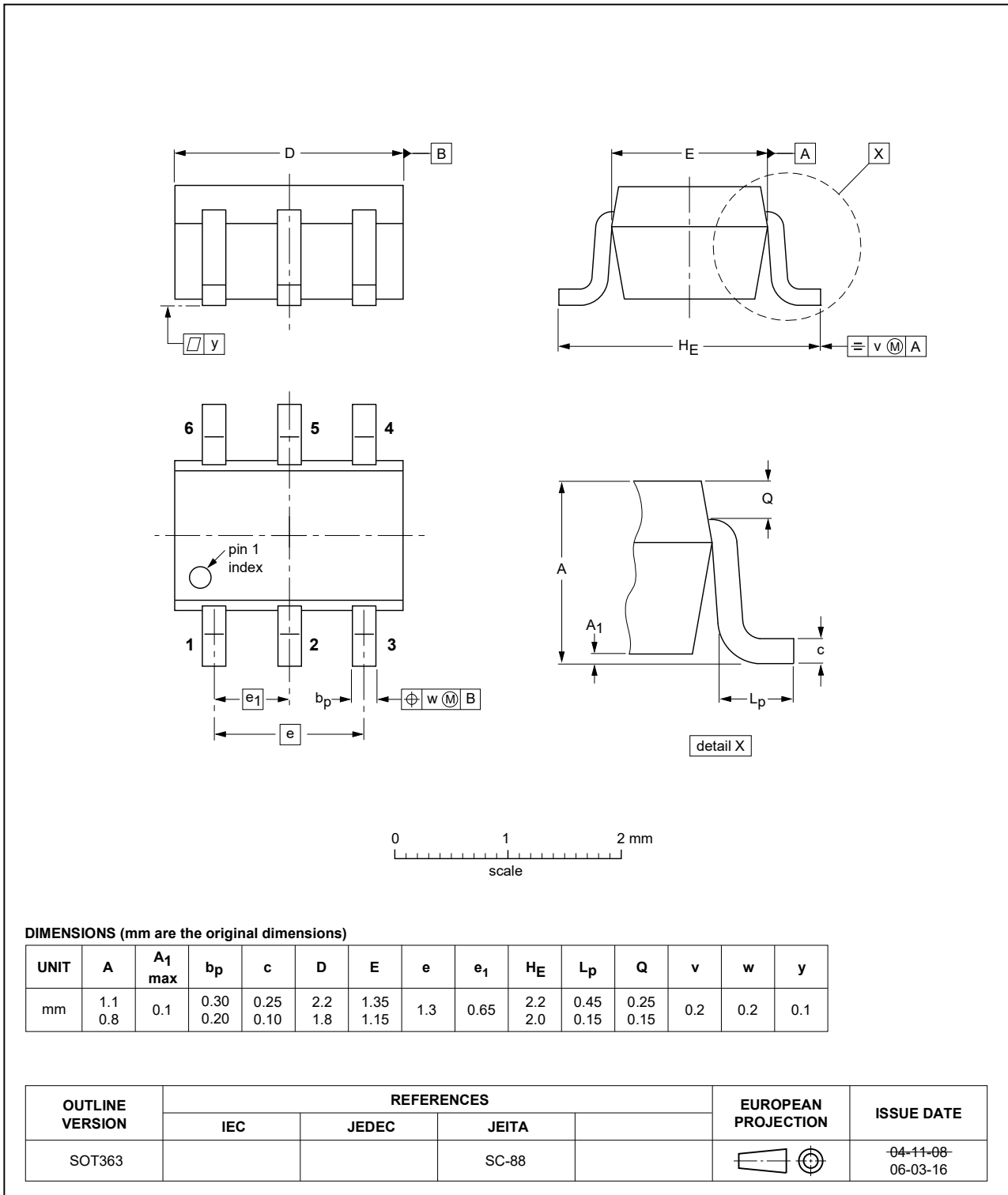

Fig. 8. Package outline SOT363 (SC-88)

Plastic, surface-mounted package (SC-74; TSOP6); 6 leads

SOT457



Fig. 9. Package outline SOT457 (SC-74)

13. Abbreviations

Table 11. Abbreviations

Acronym	Description
CMOS	Complementary Metal Oxide Semiconductor
DUT	Device Under Test
ESD	ElectroStatic Discharge
HBM	Human Body Model
MIL	Military
MM	Machine Model
TTL	Transistor-Transistor Logic

14. Revision history

Table 12. Revision history

Document ID	Release date	Data sheet status	Change notice	Supersedes
74LVC1G175_Q100 v.3	20191003	Product data sheet	-	74LVC1G175_Q100 v.2
Modifications:	<ul style="list-style-type: none"> The format of this data sheet has been redesigned to comply with the identity guidelines of Nexperia. Legal texts have been adapted to the new company name where appropriate. Table 5: Derating values for P_{tot} total power dissipation updated. Package outline drawing SOT457 (SC-74) updated. 			
74LVC1G175_Q100 v.2	20161209	Product data sheet	-	74LVC1G175_Q100 v.1
Modifications:	<ul style="list-style-type: none"> Table 7: The maximum limits for leakage current and supply current have changed. 			
74LVC1G175_Q100 v.1	20131115	Product data sheet	-	-

15. Legal information

Data sheet status

Document status [1][2]	Product status [3]	Definition
Objective [short] data sheet	Development	This document contains data from the objective specification for product development.
Preliminary [short] data sheet	Qualification	This document contains data from the preliminary specification.
Product [short] data sheet	Production	This document contains the product specification.

- [1] Please consult the most recently issued document before initiating or completing a design.
- [2] The term 'short data sheet' is explained in section "Definitions".
- [3] The product status of device(s) described in this document may have changed since this document was published and may differ in case of multiple devices. The latest product status information is available on the internet at <https://www.nexperia.com>.

Definitions

Draft — The document is a draft version only. The content is still under internal review and subject to formal approval, which may result in modifications or additions. Nexperia does not give any representations or warranties as to the accuracy or completeness of information included herein and shall have no liability for the consequences of use of such information.

Short data sheet — A short data sheet is an extract from a full data sheet with the same product type number(s) and title. A short data sheet is intended for quick reference only and should not be relied upon to contain detailed and full information. For detailed and full information see the relevant full data sheet, which is available on request via the local Nexperia sales office. In case of any inconsistency or conflict with the short data sheet, the full data sheet shall prevail.

Product specification — The information and data provided in a Product data sheet shall define the specification of the product as agreed between Nexperia and its customer, unless Nexperia and customer have explicitly agreed otherwise in writing. In no event however, shall an agreement be valid in which the Nexperia product is deemed to offer functions and qualities beyond those described in the Product data sheet.

Disclaimers

Limited warranty and liability — Information in this document is believed to be accurate and reliable. However, Nexperia does not give any representations or warranties, expressed or implied, as to the accuracy or completeness of such information and shall have no liability for the consequences of use of such information. Nexperia takes no responsibility for the content in this document if provided by an information source outside of Nexperia.

In no event shall Nexperia be liable for any indirect, incidental, punitive, special or consequential damages (including - without limitation - lost profits, lost savings, business interruption, costs related to the removal or replacement of any products or rework charges) whether or not such damages are based on tort (including negligence), warranty, breach of contract or any other legal theory.

Notwithstanding any damages that customer might incur for any reason whatsoever, Nexperia's aggregate and cumulative liability towards customer for the products described herein shall be limited in accordance with the Terms and conditions of commercial sale of Nexperia.

Right to make changes — Nexperia reserves the right to make changes to information published in this document, including without limitation specifications and product descriptions, at any time and without notice. This document supersedes and replaces all information supplied prior to the publication hereof.

Suitability for use in automotive applications — This Nexperia product has been qualified for use in automotive applications. Unless otherwise agreed in writing, the product is not designed, authorized or warranted to be suitable for use in life support, life-critical or safety-critical systems or

equipment, nor in applications where failure or malfunction of an Nexperia product can reasonably be expected to result in personal injury, death or severe property or environmental damage. Nexperia and its suppliers accept no liability for inclusion and/or use of Nexperia products in such equipment or applications and therefore such inclusion and/or use is at the customer's own risk.

Quick reference data — The Quick reference data is an extract of the product data given in the Limiting values and Characteristics sections of this document, and as such is not complete, exhaustive or legally binding.

Applications — Applications that are described herein for any of these products are for illustrative purposes only. Nexperia makes no representation or warranty that such applications will be suitable for the specified use without further testing or modification.

Customers are responsible for the design and operation of their applications and products using Nexperia products, and Nexperia accepts no liability for any assistance with applications or customer product design. It is customer's sole responsibility to determine whether the Nexperia product is suitable and fit for the customer's applications and products planned, as well as for the planned application and use of customer's third party customer(s). Customers should provide appropriate design and operating safeguards to minimize the risks associated with their applications and products.

Nexperia does not accept any liability related to any default, damage, costs or problem which is based on any weakness or default in the customer's applications or products, or the application or use by customer's third party customer(s). Customer is responsible for doing all necessary testing for the customer's applications and products using Nexperia products in order to avoid a default of the applications and the products or of the application or use by customer's third party customer(s). Nexperia does not accept any liability in this respect.

Limiting values — Stress above one or more limiting values (as defined in the Absolute Maximum Ratings System of IEC 60134) will cause permanent damage to the device. Limiting values are stress ratings only and (proper) operation of the device at these or any other conditions above those given in the Recommended operating conditions section (if present) or the Characteristics sections of this document is not warranted. Constant or repeated exposure to limiting values will permanently and irreversibly affect the quality and reliability of the device.

Terms and conditions of commercial sale — Nexperia products are sold subject to the general terms and conditions of commercial sale, as published at <http://www.nexperia.com/profile/terms>, unless otherwise agreed in a valid written individual agreement. In case an individual agreement is concluded only the terms and conditions of the respective agreement shall apply. Nexperia hereby expressly objects to applying the customer's general terms and conditions with regard to the purchase of Nexperia products by customer.

No offer to sell or license — Nothing in this document may be interpreted or construed as an offer to sell products that is open for acceptance or the grant, conveyance or implication of any license under any copyrights, patents or other industrial or intellectual property rights.

Export control — This document as well as the item(s) described herein may be subject to export control regulations. Export might require a prior authorization from competent authorities.

Translations — A non-English (translated) version of a document is for reference only. The English version shall prevail in case of any discrepancy between the translated and English versions.

Trademarks

Notice: All referenced brands, product names, service names and trademarks are the property of their respective owners.

Contents

1. General description	1
2. Features and benefits	1
3. Ordering information	1
4. Marking	2
5. Functional diagram	2
6. Pinning information	2
6.1. Pinning.....	2
6.2. Pin description.....	3
7. Functional description	3
8. Limiting values	3
9. Recommended operating conditions	4
10. Static characteristics	4
11. Dynamic characteristics	6
11.1. Waveforms.....	7
12. Package outline	9
13. Abbreviations	11
14. Revision history	11
15. Legal information	12

© Nexperia B.V. 2019. All rights reserved

For more information, please visit: <http://www.nexperia.com>

For sales office addresses, please send an email to: salesaddresses@nexperia.com

Date of release: 3 October 2019
