

## High-Efficiency Low EMI Boost Regulator

### Features

- Over 80% Efficient at 1 mA Load
- 2.5V to 5.5V Input Voltage Range
- Output Voltage Adjustable to 37V
- 1.6A Switch Current (typ.)
- 52  $\mu$ A (typ.) Quiescent Current
- Constant Peak Current Control Reduces Output Ripple
- EMI Reduction Circuitry
- Stable with Small Ceramic Capacitors
- <1  $\mu$ A Shutdown Current
- UVLO and Thermal Shutdown
- 8-Pin 2 mm x 2 mm Leadless DFN Package (MIC2251)
- 5-Pin Thin SOT-23 Package (MIC2251-1 & MIC2251-2) Pin to Pin Compatible with MCP1661/3 (1.2A/1.8A Switch Current)
- -40°C to +125°C Junction Temperature Range

### Applications

- LCD/OLED Display Bias Supply
- CCD Bias Supply
- Mobile Phones, PDA, Media Players, GPS PND
- Haptic Displays
- Local 5V, 15V, 24V Rail

### General Description

The MIC2251 is a general purpose DC/DC boost switching regulator that features low noise, EMI reduction circuitry, and high efficiency across a wide output current range.

The MIC2251 is optimized for noise-sensitive hand held battery powered applications. A proprietary control method allows low ripple across the output voltage and current ranges. The MIC2251 incorporates a pseudo-random dithering function to reduce EMI levels up to 10 dB enabled by the DITH pin.

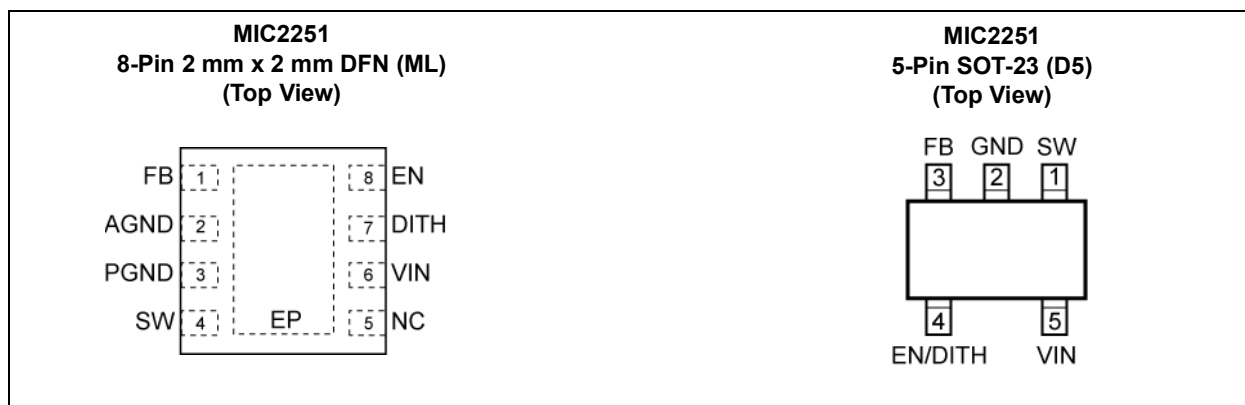
The MIC2251 is designed for use with inductor values from 4.7  $\mu$ H to 22  $\mu$ H, and is stable with ceramic capacitors from 1  $\mu$ F to 22  $\mu$ F.

The MIC2251 attains a high peak efficiency up to 90% at 100 mA and excellent light load efficiency of 80% at 1 mA.

The MIC2251-1 is available in a 5-pin Thin SOT-23 package with dithering disabled, while the MIC2251-2 is available in a 5-pin Thin SOT-23 package with dithering enabled.

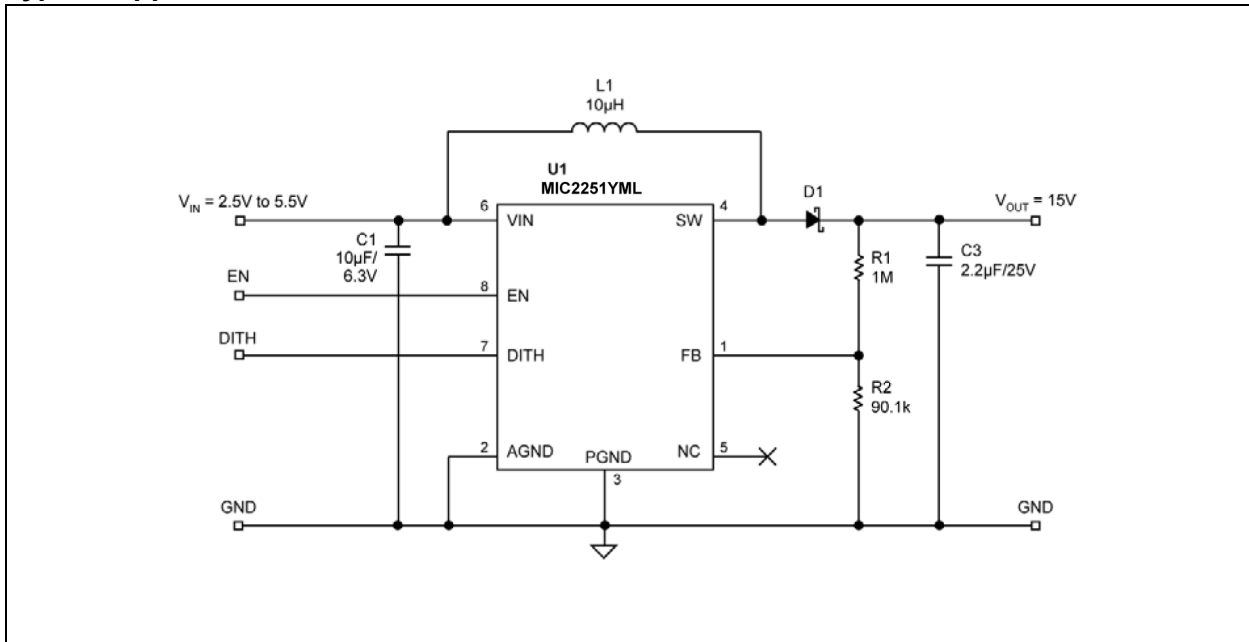
The MIC2251 is available in a 8-pin 2 mm x 2 mm DFN leadless package option with an operating junction temperature range of -40°C to +125°C.

### Package Types

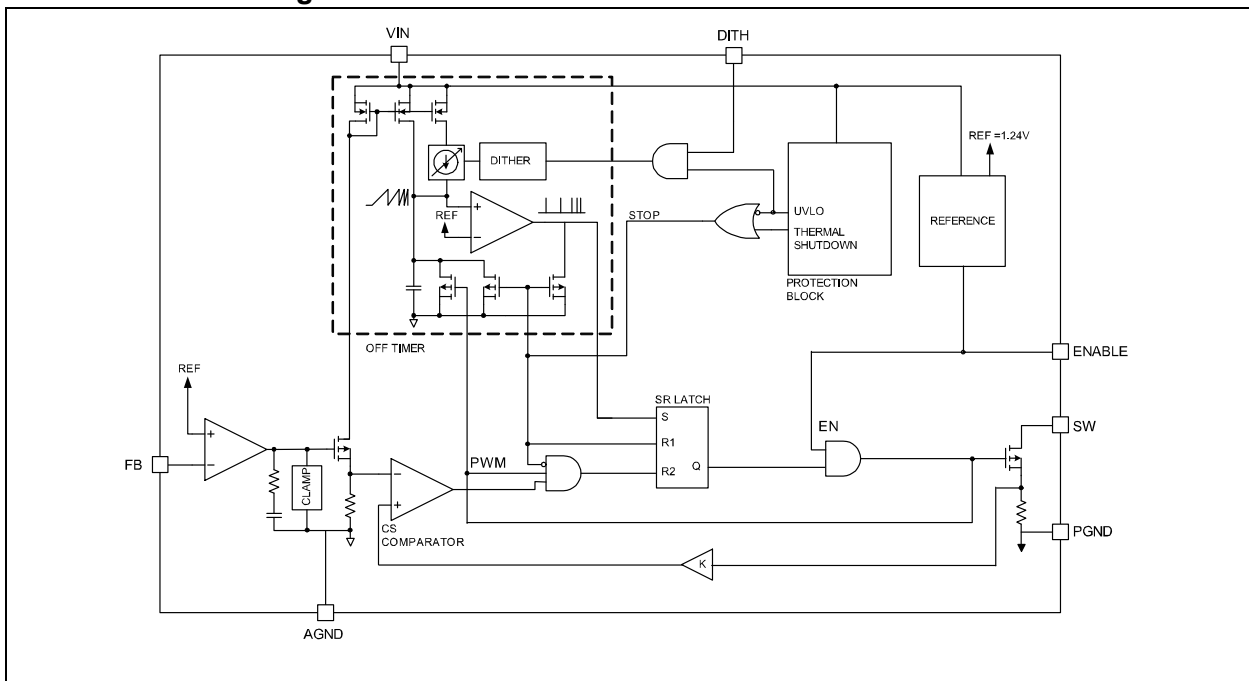


# MIC2251

## Typical Application Schematic



## Functional Block Diagram



## 1.0 ELECTRICAL CHARACTERISTICS

### Absolute Maximum Ratings †

Supply Voltage ( $V_{IN}$ )	+6V
Switch Voltage ( $V_{SW}$ )	-0.3V to +40V
Enable Voltage ( $V_{EN}$ )	-0.3V to $V_{IN}$
FB Voltage ( $V_{FB}$ )	+6V
Switch Current ( $I_{SW}$ )	3.5A
ESD Rating (Note 1)	200V

### Operating Ratings ‡

Supply Voltage ( $V_{IN}$ )	+2.5V to +5.5V
Enable Voltage ( $V_{EN}$ )	0V to $V_{IN}$

† **Notice:** Stresses above those listed under “Absolute Maximum Ratings” may cause permanent damage to the device. This is a stress rating only and functional operation of the device at those or any other conditions above those indicated in the operational sections of this specification is not intended. Exposure to maximum rating conditions for extended periods may affect device reliability.

‡ **Notice:** The device is not guaranteed to function outside its operating ratings.

**Note 1:** Devices are ESD sensitive. Handling precautions are recommended. Human body model, 1.5 k $\Omega$  in series with 100 pF.

## ELECTRICAL CHARACTERISTICS

**Electrical Characteristics:**  $V_{IN} = V_{EN} = 3.6V$ ;  $V_{DITH} = 0V$ ;  $V_{OUT} = 15V$ ;  $I_{OUT} = 40 mA$ ;  $T_A = +25^\circ C$ , unless otherwise noted. **Bold** values indicate  $-40^\circ C \leq T_J \leq +85^\circ C$ . Specification for packaged product only.

Parameter	Symbol	Min.	Typ.	Max.	Units	Conditions
Input Voltage Range	$V_{IN}$	2.5	—	5.5	V	—
Undervoltage Lockout	$V_{UVLO}$	1.8	2	2.4	V	$V_{IN}$ rising
Quiescent Current	$I_Q$	—	70	<b>120</b>	$\mu A$	$V_{FB} = 1.5V$ (not switching)
Shutdown Current	$I_{SD}$	—	0.1	<b>1</b>	$\mu A$	$V_{EN} = 0V$ , $I_{SD} = I_{VIN}$
Feedback Voltage	$V_{FB}$	1.20	1.24	1.277	V	—
		<b>1.19</b>	—	<b>1.29</b>	V	$-40^\circ C \leq T_J \leq +85^\circ C$
Feedback Input Current	$I_{FB}$	—	10	—	nA	$V_{FB} = 1.24V$
<b>PFM Operation</b>						
Soft-Start Time	$t_{SS}$	—	1	—	ms	—
Switch Off-Time	$t_{SW}$	—	1.6	—	$\mu s$	$V_{IN} = 3.6V$
Maximum Duty Cycle	$D_{MAX}$	75	87	—	%	—
Off-Time Dithering	$t_{DITH}$	—	$\pm 20$	—	%	$V_{DITH} = 3.6V$ . Percentage from nominal.
Line Regulation	LINE_REG	—	0.3	<b>2</b>	%	$3V \leq V_{IN} \leq 5V$
Load Regulation	LOAD_REG	—	0.1	<b>2</b>	%	$1 mA \leq I_{OUT} \leq 40 mA$
Switch Current-Limit	$I_{SW}$	0.9	1.6	—	A	—
Switch ON-Resistance	$R_{ON}$	—	0.7	1	$\Omega$	$I_{SW} = 200 mA$
Switch Leakage Current	$I_{LK}$	—	0.01	<b>5</b>	$\mu A$	$V_{EN} = 0V$ , $V_{SW} = 10V$
Logic Input Thresholds	$V_{EN}$ , $V_{DITH}$	<b>1.5</b>	—	—	V	Turn On
		—	—	<b>0.4</b>	V	Turn Off
Enable Pin Current	$I_{EN}$	—	0.1	2	$\mu A$	$V_{EN} = V_{IN} = 5.0V$
Thermal Shutdown Threshold	$T_{TSD}$	—	130	—	$^\circ C$	—
		—	15	—	$^\circ C$	Hysteresis

# MIC2251

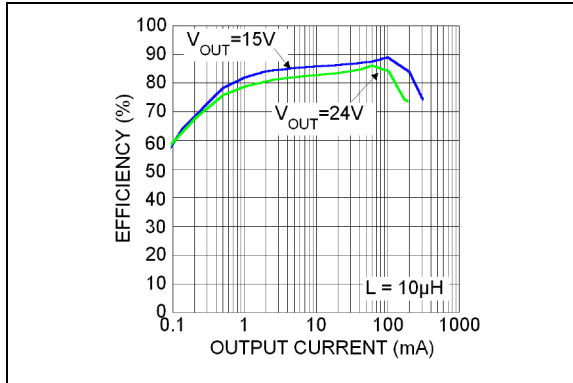
## TEMPERATURE SPECIFICATIONS

Parameters	Sym.	Min.	Typ.	Max.	Units	Conditions
<b>Temperature Ranges</b>						
Junction Operating Temperature	$T_J$	-40	—	+125	°C	(Note 1)
Ambient Storage Temperature Range	$T_S$	-65	—	+150	°C	—
<b>Package Thermal Resistance</b>						
Thermal Resistance, 2 mm x 2 mm DFN-8	$\theta_{JA}$	—	90	—	°C/W	—

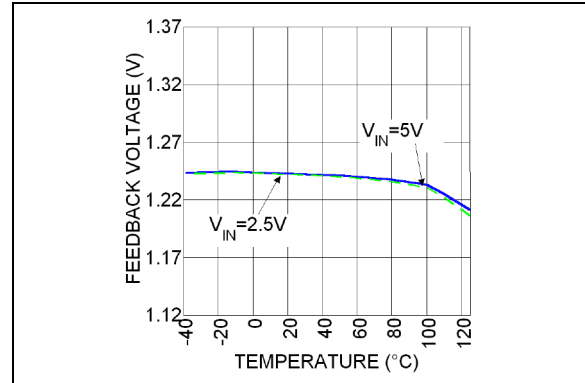
**Note 1:** The maximum allowable power dissipation is a function of ambient temperature, the maximum allowable junction temperature and the thermal resistance from junction to air (i.e.,  $T_A$ ,  $T_J$ ,  $\theta_{JA}$ ). Exceeding the maximum allowable power dissipation will cause the device operating junction temperature to exceed the maximum +125°C rating. Sustained junction temperatures above +125°C can impact the device reliability.

## 2.0 TYPICAL PERFORMANCE CURVES

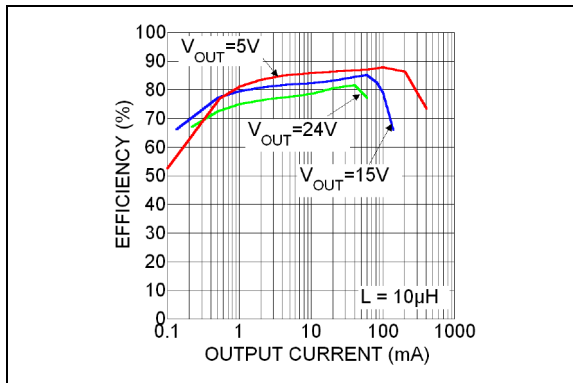
**Note:** The graphs and tables provided following this note are a statistical summary based on a limited number of samples and are provided for informational purposes only. The performance characteristics listed herein are not tested or guaranteed. In some graphs or tables, the data presented may be outside the specified operating range (e.g., outside specified power supply range) and therefore outside the warranted range.



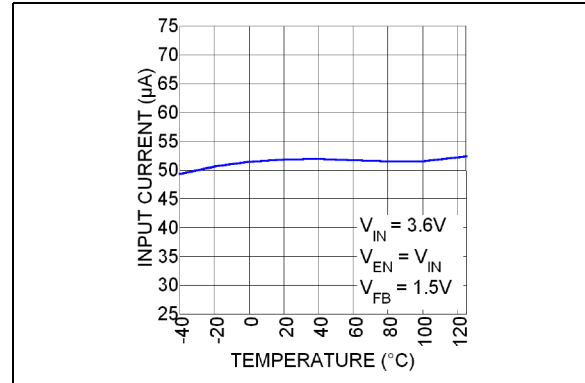
**FIGURE 2-1:** Efficiency  $V_{IN} = 5V$ .



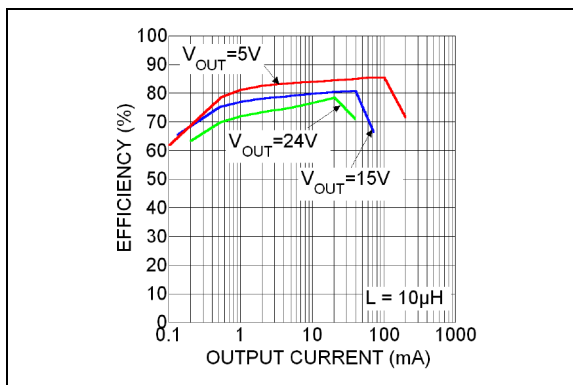
**FIGURE 2-4:** Feedback Voltage vs. Temperature.



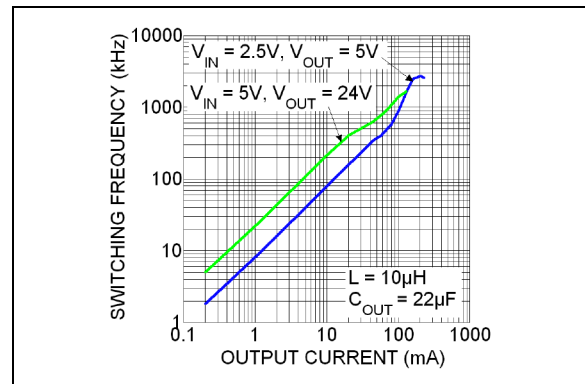
**FIGURE 2-2:** Efficiency  $V_{IN} = 3.3V$ .



**FIGURE 2-5:** Input Current vs. Temperature.

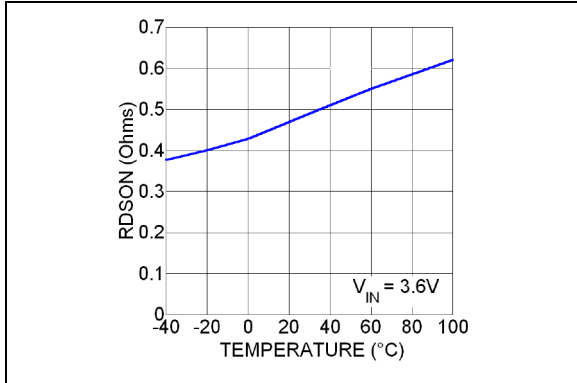


**FIGURE 2-3:** Efficiency  $V_{IN} = 2.5V$ .

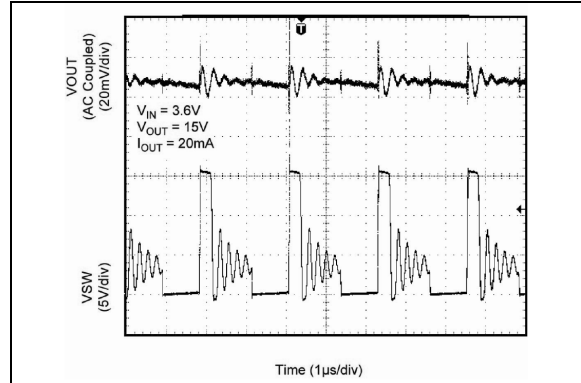


**FIGURE 2-6:** Switching Frequency vs. Load Current.

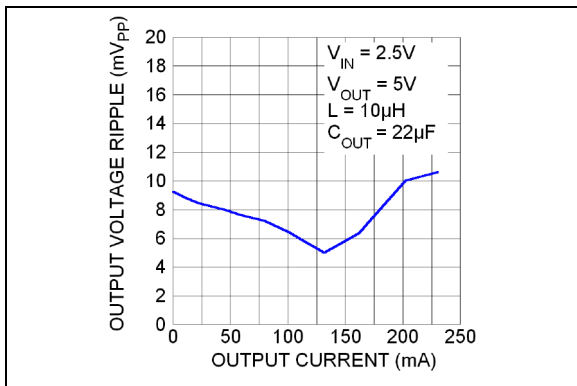
# MIC2251



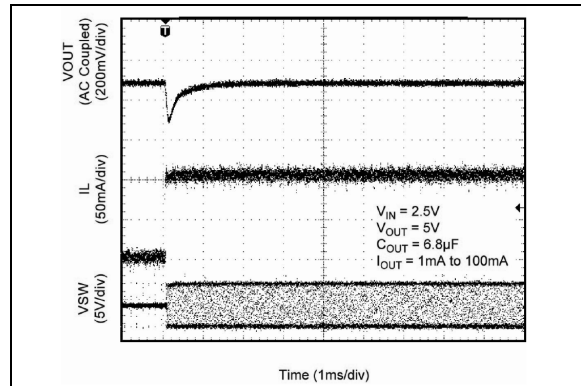
**FIGURE 2-7:**  $R_{DS(ON)}$  vs. Temperature.



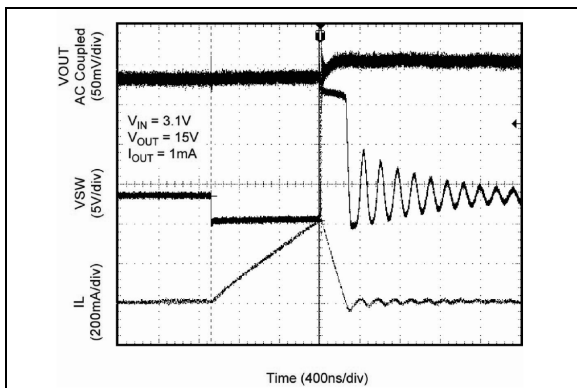
**FIGURE 2-10:** Switching Waveform.



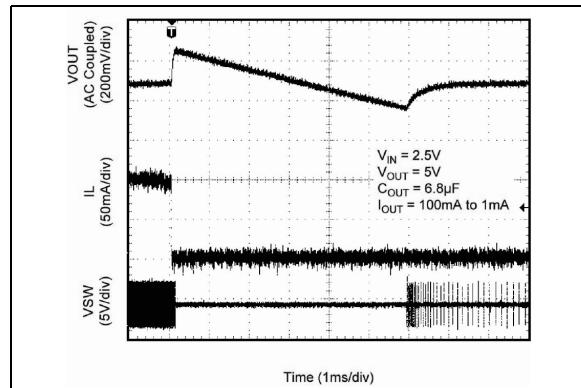
**FIGURE 2-8:** Output Voltage Ripple vs. Load Current.



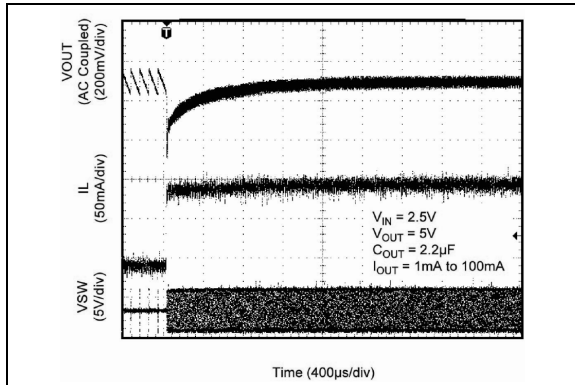
**FIGURE 2-11:** Load Transient Response.



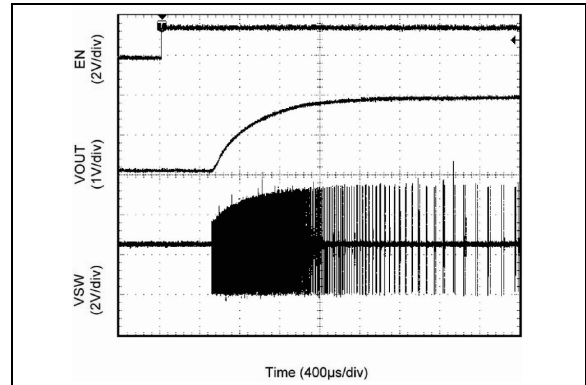
**FIGURE 2-9:** Switching Waveform.



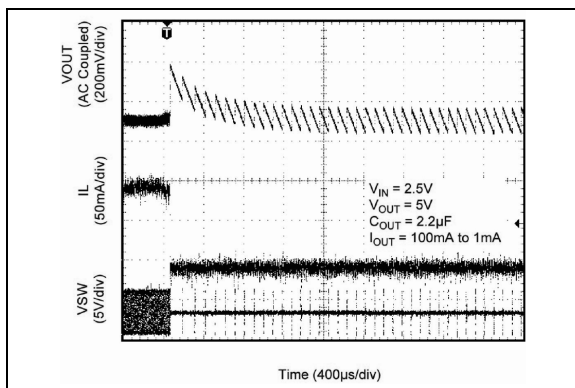
**FIGURE 2-12:** Load Transient Response.



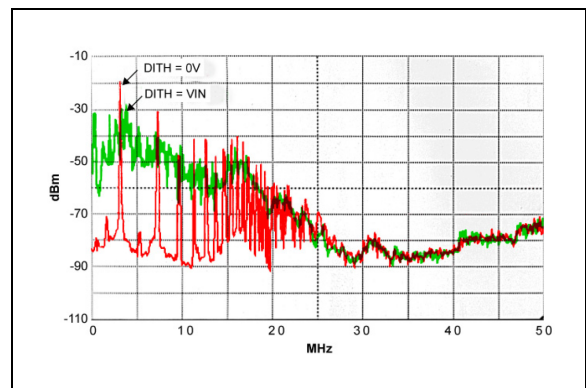
**FIGURE 2-13:** Load Transient Response.



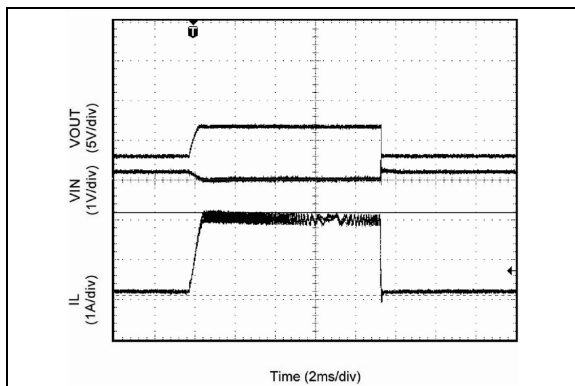
**FIGURE 2-16:** Start-Up Waveform.



**FIGURE 2-14:** Load Transient Response.



**FIGURE 2-17:** EMI Improvement Using Dithering.



**FIGURE 2-15:** Current Limit.

# MIC2251

## 3.0 PIN DESCRIPTIONS

The descriptions of the pins are listed in [Table 3-1](#).

**TABLE 3-1: PIN FUNCTION TABLE**

Pin Number MIC2251YML	Pin Number MIC2251-1YD5	Pin Number MIC2251-2YD5	Pin Name	Description
1	3	3	FB	Feedback (Input): 1.24V output voltage sense node. $V_{OUT} = 1.24V (1 + R1/R2)$
2	—	—	AGND	Analog Ground. Connect to power ground.
3	2	2	PGND	Power Ground.
4	1	1	SW	Switch Node (Input): Internal power NMOS drain.
5	—	—	NC	Not internally connected.
6	5	5	VIN	Supply (Input): 2.5V to 5.5V input voltage.
7	—	4	DITH	Frequency Dithering (Input): Connect this pin high to enable pseudo-random on-time dithering to reduce EMI. Connect this pin to ground to disable this function.
8	4	4	EN	Enable (Input): Logic high enables the regulator. Logic low shuts down the regulator. Do not leave floating.
EP	—	—	HS PAD	Ground (Return): Exposed backside pad. Connect to power ground.



## 4.0 FUNCTIONAL DESCRIPTION

### 4.1 VIN

The input supply ( $V_{IN}$ ) provides power to the internal MOSFETs and control circuitry for the switch mode regulator. The operating input voltage range is from 2.5V to 5.5V. An input capacitor with a minimum voltage rating of 6.3V is recommended.

### 4.2 EN

A logic level input of 1.5V or higher enables the regulator. A logic input of 0.4V or less places the regulator in shutdown mode which reduces the supply current to less than 1  $\mu$ A. The MIC2251 features built-in soft-start circuitry that reduces in-rush current and prevents the output voltage from overshooting during startup. Do not leave the Enable pin floating.

### 4.3 SW

The MIC2251 has an internal MOSFET switch that connects directly to one end of the inductor (SW pin) and provides a current path to ground during switching cycles. The source of the internal MOSFET connects through a current sense resistor to ground.

### 4.4 PGND

The power ground pin is the high current path to ground. The current loop for the power ground should be as small as possible and separate from the analog ground (AGND).

### 4.5 AGND

Analog ground (AGND) is the ground path for the biasing and control circuitry. The current loop for the signal ground should be separate from the power ground (PGND) loop.

### 4.6 DITH

The DITH function is a frequency dithering technique that reduces EMI noise by spreading the boost regulators' noise spectrum. This technique reduces the EMI peaks by distributing the switching frequency across a wider spectrum. Connect this pin high to enable the pseudo-random on-time dithering. Connect this pin to ground to disable this function.

### 4.7 FB

The feedback pin (FB) allows the regulated output voltage to be set by applying an external resistor divider network. The internal reference voltage is 1.24V. The output voltage is calculated from the following equation:

#### EQUATION 4-1:

$$V_{OUT} = 1.24V \left( 1 + \frac{R1}{R2} \right)$$

# MIC2251

## 5.0 APPLICATION INFORMATION

### 5.1 Overview

The MIC2251 boost regulator utilizes a combination of PFM and current mode regulation to achieve very high efficiency over a wide range of output load. This innovative design is the basis for the regulator's high efficiency, excellent stability and self-compensation technique. The boost regulator performs a power conversion that results in an output voltage that is greater than the input. Operation starts with activating an internal MOSFET switch that draws current through the inductor (L1). While one end of the inductor is fixed at  $V_{IN}$ , the other end is switched up and down. While the switch is on, the current through the inductor increases. When the switch is off the inductor current continues to flow through the output diode.

The current flow imposes a voltage across the inductor, which is added to  $V_{IN}$  to produce a higher voltage  $V_{OUT}$ . At low power levels (typically less than 1W), the period varies between switching cycles, indicative of pulse frequency modulation (PFM). As the output power increases beyond approximately 1W, the period between switching cycles continues to decrease and the power (switch current) delivered with each cycle increases indicative of current mode regulation.

### 5.2 PFM Regulation

The error amplifier compares the regulator's reference voltage with the feedback voltage obtained from the output resistor voltage divider network. The resulting error voltage acts as a correction input signal to the control block. The control block generates two signals that turn on and off the output MOSFET switch. An increase in load current causes  $V_{OUT}$  and  $V_{FB}$  to decrease in value. The control loop then changes the switching frequency to increase the energy transferred to the output capacitor to regulate the output voltage. A reduction in load causes  $V_{OUT}$  and  $V_{FB}$  to increase. Now the control loop compensates by reducing the effective switching frequency, thus reducing the amount of energy delivered to the output capacitor in order to keep the output voltage within regulation.

### 5.3 Current Mode Regulation

The control block's oscillator starts the cycle by setting the MOSFET switch control flip flop. The switch then turns on. This flip flop is reset when the switch current ramp reaches the threshold set by the error amplifier. If the error amplifier indicates that  $V_{FB}$  is either too high or too low, then the threshold for the comparator measuring the switch current is appropriately adjusted to bring  $V_{OUT}$  within regulation limits. The level of the error signal also sets the off time of the switch. A higher error signal (output voltage is low) will reduce off time

to increase energy transfer to the output. A lower error signal (output voltage is high) will conversely, increase off time to reduce energy transfer to the output.

## 5.4 Component Selection

### RESISTORS

An external resistive divider network (R1 and R2) with its center tap connected to the feedback pin sets the output voltage. The appropriate R1 and R2 values for the desired output voltage are calculated by:

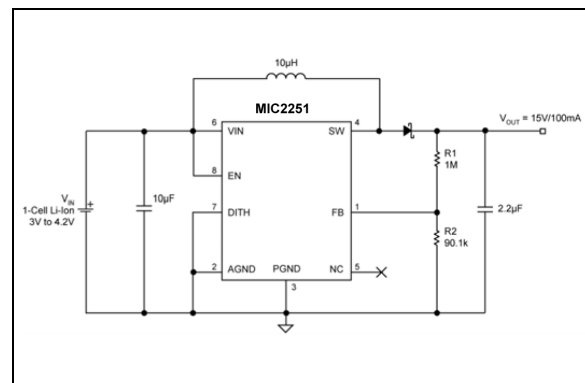
### EQUATION 5-1:

$$R2 = \frac{R1}{\left(\frac{V_{OUT}}{1.24V} - 1\right)}$$

Large resistor values are recommended to reduce light load operating current, and improve efficiency. The table below gives a good compromise between quiescent current and accuracy. Additionally, a feed-forward capacitor ( $C_{FF}$ ) placed in parallel with R1 may be added to improve transient performance. Recommended values are suggested below:

**TABLE 5-1: RECOMMENDED R1 AND  $C_{FF}$  VALUES**

$V_{OUT}$	Suggested R1	$C_{FF}$
5V to 10V	100 k $\Omega$	4.7 nF
10V to 15V	240 k $\Omega$	2.2 nF
15V to 37V	1M $\Omega$	470 pF

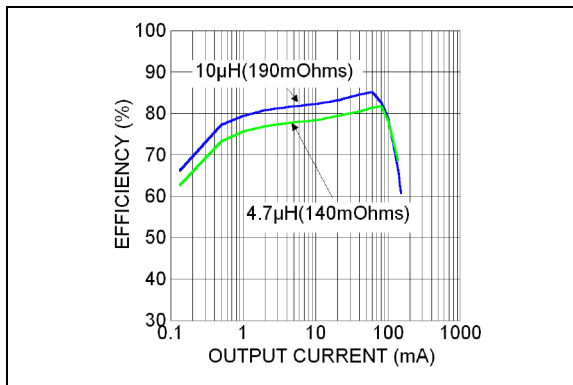


**FIGURE 5-1: Typical Application Circuit.**

### INDUCTOR

Inductor selection is a balance between efficiency, stability, cost, size, and rated current. For most applications, inductors in the range 4.7  $\mu$ H to 22  $\mu$ H are

recommended. Larger inductance values reduce the peak-to-peak ripple current, thereby reducing both the DC losses and the transition losses for better efficiency. The inductor's DC resistance (DCR) also plays an important role. Because the majority of the input current (minus the MIC2251 operating current) is passed through the inductor, higher DCR inductors will reduce efficiency at higher load currents. Figure 5-2 shows the comparison of efficiency between a 140 mΩ DCR, 4.7 μH inductor and a 190 mΩ DCR, 10 μH inductor. The switch current-limit for the MIC2251 is typically 1.6A. The saturation current rating of the selected inductor should be 20-30% higher than the 1.6A specification for proper operation.



**FIGURE 5-2:** Efficiency Comparison between Lower and Higher Inductor Values.

## INPUT CAPACITOR

The boost converter exhibits a triangular current waveform at its input, so an input capacitor is required to decouple this waveform and thereby reduce the input voltage ripple. A 10 μF to 22 μF ceramic capacitor should be sufficient for most applications. A minimum input capacitance of 1 μF is recommended. The input capacitor should be as close as possible to the inductor and the MIC2251, with short PCB traces for good noise performance.

## OUTPUT CAPACITOR

Output capacitor selection is also a trade-off between performance, size, and cost. Increasing  $C_{OUT}$  will lead to an improved transient response however the size and cost also increase. X5R and X7R ceramic capacitors are recommended. For most applications, 2.2 μF to 22 μF should be sufficient.

## DIODE

The MIC2251 requires an external diode for operation. The diode must be rated for the peak inductor current, and its reverse voltage rating must be greater than the output voltage. A Schottky diode is recommended for lower output voltages due to its lower forward voltage drop and reverse recovery time. However, at higher output voltages (>10V), a high speed diode such as LS4148 can be more efficient because it has the advantage of considerably lower leakage currents, especially at higher temperatures. This will greatly improve light load efficiency when compared to a Schottky diode.

For example: At 70°C ambient temperature,  $V_{IN} = 2.5V$ ,  $V_{OUT} = 24V$  at no load.

Input current (Vishay SL04 Schottky) = 2.1 mA.

Input current (Generic LS4148) = 0.37 mA.

## 6.0 PACKAGING INFORMATION

### 6.1 Package Marking Information

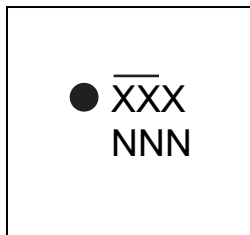
5-Lead SOT-23\*



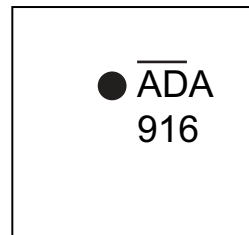
Example



8-Lead DFN\*



Example



<b>Legend:</b>	XX...X	Product code or customer-specific information
	Y	Year code (last digit of calendar year)
	YY	Year code (last 2 digits of calendar year)
	WW	Week code (week of January 1 is week '01')
	NNN	Alphanumeric traceability code
	(e3)	Pb-free JEDEC® designator for Matte Tin (Sn)
	*	This package is Pb-free. The Pb-free JEDEC designator ((e3)) can be found on the outer packaging for this package.
	●, ▲, ▼	Pin one index is identified by a dot, delta up, or delta down (triangle mark).
<b>Note:</b>	In the event the full Microchip part number cannot be marked on one line, it will be carried over to the next line, thus limiting the number of available characters for customer-specific information. Package may or may not include the corporate logo.	
	Underbar (̄) symbol may not be to scale.	

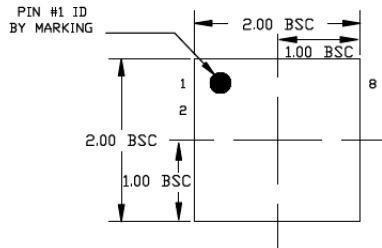
## 8-Lead DFN 2 mm x 2 mm Package Outline and Recommended Land Pattern

**Note:** For the most current package drawings, please see the Microchip Packaging Specification located at <http://www.microchip.com/packaging>

**TITLE**

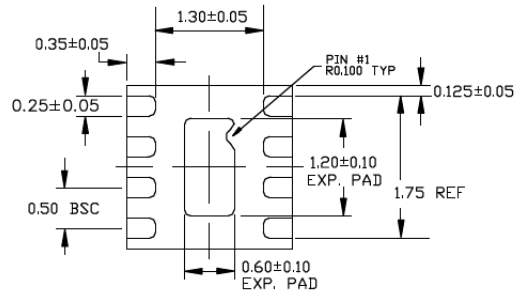
8 LEAD DFN 2x2mm PACKAGE OUTLINE & RECOMMENDED LAND PATTERN

DRAWING #	DFN22-8LD-PL-1	UNIT	MM
-----------	----------------	------	----



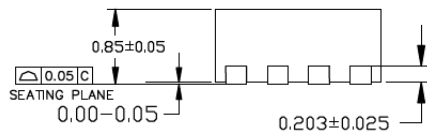
TOP VIEW

NOTE: 1, 2, 3



BOTTOM VIEW

NOTE: 1, 2, 3



END VIEW

NOTE: 1, 2, 3

**NOTE:**

1. MAX PACKAGE WARPAGE IS 0.05 MM
2. MAX ALLOWABLE BURR IS 0.076MM IN ALL DIRECTIONS
3. PIN #1 IS ON TOP WILL BE LASER MARKED
4. RED CIRCLE IN LAND PATTERN INDICATE THERMAL VIA. SIZE SHOULD BE 0.30-0.35MM IN DIAMETER AND SHOULD BE CONNECTED TO GND FOR MAX THERMAL PERFORMANCE
5. GREEN RECTANGLES (SHADED AREA) INDICATE SOLDER STENCIL OPENING ON EXPOSED PAD AREA. SIZE SHOULD BE 0.60x0.40 MM IN SIZE, 0.20 MM SPACING.

**Note:** For the most current package drawings, please see the Microchip Packaging Specification located at <http://www.microchip.com/packaging>.

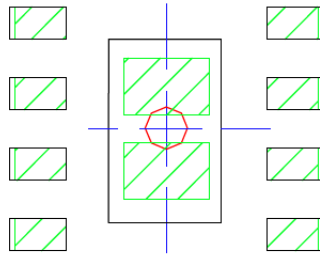
# MIC2251

## 8-Lead DFN 2 mm x 2 mm Package Recommended Land Pattern

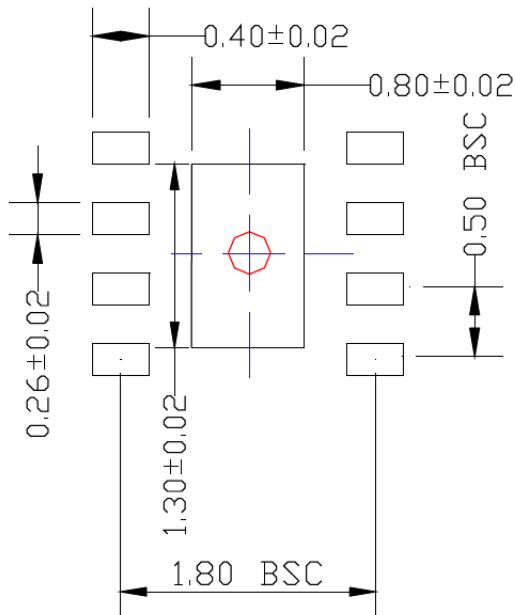
POD-Land Pattern Drawing # DFN22-8LD-PL-1

### RECOMMENDED LAND PATTERN

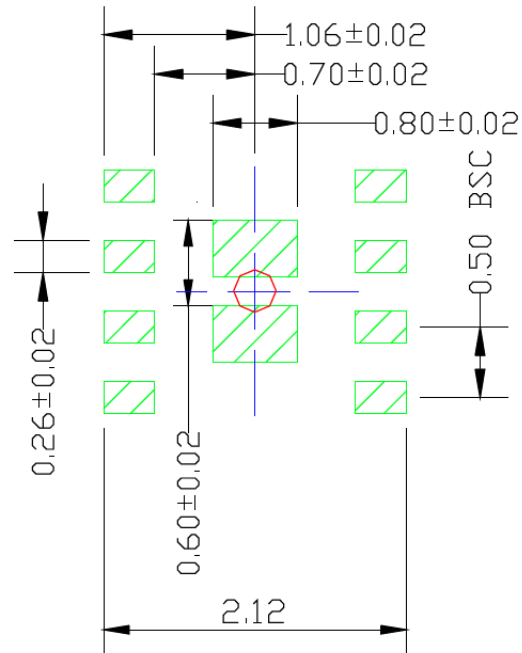
NOTE: 4, 5



STACKED-UP



EXPOSED METAL TRACE



SOLDER STENCIL OPENING

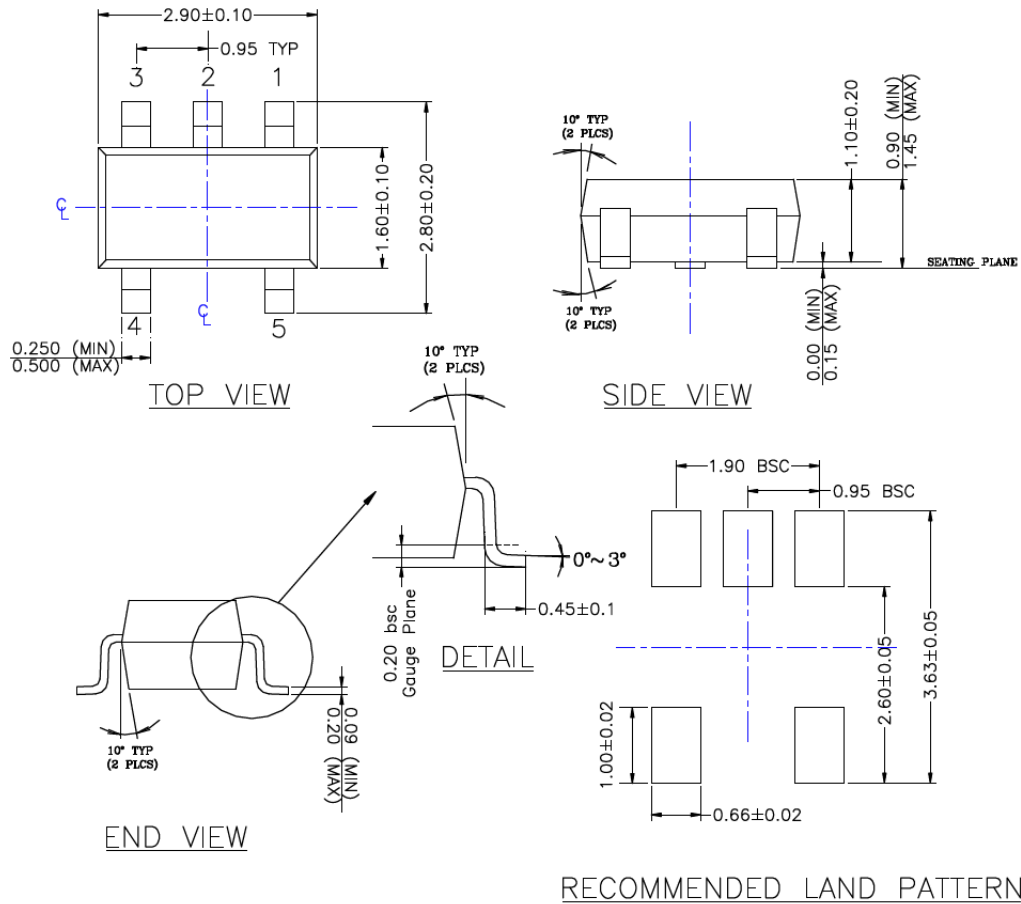
Note: For the most current package drawings, please see the Microchip Packaging Specification located at <http://www.microchip.com/packaging>.

## 5-Lead SOT-23-5 Package Outline and Recommended Land Pattern

**TITLE**

5 LEAD SOT23 PACKAGE OUTLINE & RECOMMENDED LAND PATTERN

<b>DRAWING #</b>	SOT23-5LD-PL-1	<b>UNIT</b>	MM
------------------	----------------	-------------	----



**NOTE:**

1. PACKAGE OUTLINE EXCLUSIVE OF MOLD FLASH & BURR.
2. PACKAGE OUTLINE INCLUSIVE OF SOLER PLATING.
3. DIMENSION AND TOLERANCE PER ANSI Y14.5M, 1982.
4. FOOT LENGTH MEASUREMENT BASED ON GAUGE PLANE METHOD.
5. DIE FACES UP FOR MOLD, AND FACES DOWN FOR TRIM/FORM.
6. ALL DIMENSIONS ARE IN MILLIMETERS.

Note: For the most current package drawings, please see the Microchip Packaging Specification located at <http://www.microchip.com/packaging>.

# MIC2251

---

NOTES:



## APPENDIX A: REVISION HISTORY

### Revision A (January 2021)

- Converted Micrel document MIC2251 to Microchip data sheet DS20006487A.
- Minor text changes throughout.
- Added “Pin to Pin Compatible with MCP1661/3 (1.2A/1.8A Switch Current)” as a new bullet under [Features](#).

# MIC2251

---

NOTES:

## PRODUCT IDENTIFICATION SYSTEM

To order or obtain information, e.g., on pricing or delivery, contact your local Microchip representative or sales office.

<u>PART NO.</u>	<u>-X</u>	<u>X</u>	<u>XX</u>	<u>-XX</u>
Device	Dithering Feature	Junction Temperature Range	Package	Media Type
<b>Device:</b>	MIC2251:	High-Efficiency Low EMI Boost Regulator		
<b>Feature:</b>	-1 =	Dithering Disabled (TSOT Package)		
	-2 =	Dithering Disabled (TSOT Package)		
<b>Temperature:</b>	Y =	-40°C to +125°C (Extended Industrial, RoHS Compliant)		
<b>Package:</b>	D5 =	5-Lead Thin SOT-23		
	ML =	8-Lead Thin DFN, 2 mm x 2 mm x 0.9 mm		
<b>Media Type:</b>	TR =	3,000/Reel for D5 Package		
	TR =	5,000/Reel for ML Package		

<b>Examples:</b>	
a) MIC2251YML-TR:	High-Efficiency Low EMI Boost Regulator, Extended Industrial 40°C to +125°C Junction Temperature Range, RoHS Compliant, 8-lead DFN Package, 5,000/Reel
b) MIC2251-1YD5-TR:	High-Efficiency Low EMI Boost Regulator with Dithering Disabled, Extended Industrial -40°C to +125°C Junction Temperature Range, RoHS Compliant, 5-lead Thin SOT-23 Package, 3,000/Reel
c) MIC2251-2YD5-TR:	High-Efficiency Low EMI Boost Regulator with Dithering Enabled, Extended Industrial -40°C to +125°C Junction Temperature Range, RoHS Compliant, 5-lead Thin SOT-23 Package, 3,000/Reel
<b>Note 1:</b>	Tape and Reel identifier only appears in the catalog part number description. This identifier is used for ordering purposes and is not printed on the device package. Check with your Microchip Sales Office for package availability with the Tape and Reel option.

# MIC2251

---

NOTES:

---

**Note the following details of the code protection feature on Microchip devices:**

- Microchip products meet the specifications contained in their particular Microchip Data Sheet.
- Microchip believes that its family of products is secure when used in the intended manner and under normal conditions.
- There are dishonest and possibly illegal methods being used in attempts to breach the code protection features of the Microchip devices. We believe that these methods require using the Microchip products in a manner outside the operating specifications contained in Microchip's Data Sheets. Attempts to breach these code protection features, most likely, cannot be accomplished without violating Microchip's intellectual property rights.
- Microchip is willing to work with any customer who is concerned about the integrity of its code.
- Neither Microchip nor any other semiconductor manufacturer can guarantee the security of its code. Code protection does not mean that we are guaranteeing the product is "unbreakable." Code protection is constantly evolving. We at Microchip are committed to continuously improving the code protection features of our products. Attempts to break Microchip's code protection feature may be a violation of the Digital Millennium Copyright Act. If such acts allow unauthorized access to your software or other copyrighted work, you may have a right to sue for relief under that Act.

---

Information contained in this publication is provided for the sole purpose of designing with and using Microchip products. Information regarding device applications and the like is provided only for your convenience and may be superseded by updates. It is your responsibility to ensure that your application meets with your specifications.

THIS INFORMATION IS PROVIDED BY MICROCHIP "AS IS". MICROCHIP MAKES NO REPRESENTATIONS OR WARRANTIES OF ANY KIND WHETHER EXPRESS OR IMPLIED, WRITTEN OR ORAL, STATUTORY OR OTHERWISE, RELATED TO THE INFORMATION INCLUDING BUT NOT LIMITED TO ANY IMPLIED WARRANTIES OF NON-INFRINGEMENT, MERCHANTABILITY, AND FITNESS FOR A PARTICULAR PURPOSE OR WARRANTIES RELATED TO ITS CONDITION, QUALITY, OR PERFORMANCE.

IN NO EVENT WILL MICROCHIP BE LIABLE FOR ANY INDIRECT, SPECIAL, PUNITIVE, INCIDENTAL OR CONSEQUENTIAL LOSS, DAMAGE, COST OR EXPENSE OF ANY KIND WHATSOEVER RELATED TO THE INFORMATION OR ITS USE, HOWEVER CAUSED, EVEN IF MICROCHIP HAS BEEN ADVISED OF THE POSSIBILITY OR THE DAMAGES ARE FORESEEABLE. TO THE FULLEST EXTENT ALLOWED BY LAW, MICROCHIP'S TOTAL LIABILITY ON ALL CLAIMS IN ANY WAY RELATED TO THE INFORMATION OR ITS USE WILL NOT EXCEED THE AMOUNT OF FEES, IF ANY, THAT YOU HAVE PAID DIRECTLY TO MICROCHIP FOR THE INFORMATION. Use of Microchip devices in life support and/or safety applications is entirely at the buyer's risk, and the buyer agrees to defend, indemnify and hold harmless Microchip from any and all damages, claims, suits, or expenses resulting from such use. No licenses are conveyed, implicitly or otherwise, under any Microchip intellectual property rights unless otherwise stated.

**Trademarks**

The Microchip name and logo, the Microchip logo, Adaptec, AnyRate, AVR, AVR logo, AVR Freaks, BesTime, BitCloud, chipKIT, chipKIT logo, CryptoMemory, CryptoRF, dsPIC, FlashFlex, flexPWR, HELDO, IGL00, JukeBlox, KeeLoq, Kleer, LANCheck, LinkMD, maXStylus, maXTouch, MediaLB, megaAVR, Microsemi, Microsemi logo, MOST, MOST logo, MPLAB, OptoLyzr, PackeTime, PIC, picoPower, PICSTART, PIC32 logo, PolarFire, Prochip Designer, QTouch, SAM-BA, SenGenuity, SpyNIC, SST, SST Logo, SuperFlash, Symmetricom, SyncServer, Tachyon, TimeSource, tinyAVR, UNI/O, Vectron, and XMEGA are registered trademarks of Microchip Technology Incorporated in the U.S.A. and other countries.

AgileSwitch, APT, ClockWorks, The Embedded Control Solutions Company, EtherSynch, FlashTec, Hyper Speed Control, HyperLight Load, IntelliMOS, Libero, motorBench, mTouch, Powermite 3, Precision Edge, ProASIC, ProASIC Plus, ProASIC Plus logo, Quiet-Wire, SmartFusion, SyncWorld, Temux, TimeCesium, TimeHub, TimePictra, TimeProvider, WinPath, and ZL are registered trademarks of Microchip Technology Incorporated in the U.S.A.

Adjacent Key Suppression, AKS, Analog-for-the-Digital Age, Any Capacitor, AnyIn, AnyOut, Augmented Switching, BlueSky, BodyCom, CodeGuard, CryptoAuthentication, CryptoAutomotive, CryptoCompanion, CryptoController, dsPICDEM, dsPICDEM.net, Dynamic Average Matching, DAM, ECAN, Espresso T1S, EtherGREEN, IdealBridge, In-Circuit Serial Programming, ICSP, INICnet, Intelligent Paralleling, Inter-Chip Connectivity, JitterBlocker, maxCrypto, maxView, memBrain, Mindi, MiWi, MPASM, MPF, MPLAB Certified logo, MPLIB, MPLINK, MultiTRAK, NetDetach, Omniscient Code Generation, PICDEM, PICDEM.net, PICkit, PICtail, PowerSmart, PureSilicon, QMatrix, REAL ICE, Ripple Blocker, RTAX, RTG4, SAM-ICE, Serial Quad I/O, simpleMAP, SimpliPHY, SmartBuffer, SMART-I.S., storClad, SQI, SuperSwitcher, SuperSwitcher II, Switchtec, SynchroPHY, Total Endurance, TSHARC, USBCheck, VariSense, VectorBlox, VeriPHY, ViewSpan, WiperLock, XpressConnect, and ZENA are trademarks of Microchip Technology Incorporated in the U.S.A. and other countries.

SQTP is a service mark of Microchip Technology Incorporated in the U.S.A.

The Adaptec logo, Frequency on Demand, Silicon Storage Technology, and Symmcom are registered trademarks of Microchip Technology Inc. in other countries.

GestIC is a registered trademark of Microchip Technology Germany II GmbH & Co. KG, a subsidiary of Microchip Technology Inc., in other countries.

All other trademarks mentioned herein are property of their respective companies.

© 2021, Microchip Technology Incorporated, All Rights Reserved.

ISBN: 978-1-5224-7488-3

For information regarding Microchip's Quality Management Systems, please visit [www.microchip.com/quality](http://www.microchip.com/quality).



# MICROCHIP

## Worldwide Sales and Service

### AMERICAS

**Corporate Office**  
2355 West Chandler Blvd.  
Chandler, AZ 85224-6199  
Tel: 480-792-7200  
Fax: 480-792-7277  
Technical Support:  
<http://www.microchip.com/support>  
Web Address:  
[www.microchip.com](http://www.microchip.com)

#### Atlanta

Duluth, GA  
Tel: 678-957-9614  
Fax: 678-957-1455

#### Austin, TX

Tel: 512-257-3370

#### Boston

Westborough, MA  
Tel: 774-760-0087  
Fax: 774-760-0088

#### Chicago

Itasca, IL  
Tel: 630-285-0071  
Fax: 630-285-0075

#### Dallas

Addison, TX  
Tel: 972-818-7423  
Fax: 972-818-2924

#### Detroit

Novi, MI  
Tel: 248-848-4000

#### Houston, TX

Tel: 281-894-5983

#### Indianapolis

Noblesville, IN  
Tel: 317-773-8323  
Fax: 317-773-5453  
Tel: 317-536-2380

#### Los Angeles

Mission Viejo, CA  
Tel: 949-462-9523  
Fax: 949-462-9608  
Tel: 951-273-7800

#### Raleigh, NC

Tel: 919-844-7510

#### New York, NY

Tel: 631-435-6000

#### San Jose, CA

Tel: 408-735-9110  
Tel: 408-436-4270

#### Canada - Toronto

Tel: 905-695-1980  
Fax: 905-695-2078

### ASIA/PACIFIC

**Australia - Sydney**  
Tel: 61-2-9868-6733

**China - Beijing**  
Tel: 86-10-8569-7000

**China - Chengdu**  
Tel: 86-28-8665-5511

**China - Chongqing**  
Tel: 86-23-8980-9588

**China - Dongguan**  
Tel: 86-769-8702-9880

**China - Guangzhou**  
Tel: 86-20-8755-8029

**China - Hangzhou**  
Tel: 86-571-8792-8115

**China - Hong Kong SAR**  
Tel: 852-2943-5100

**China - Nanjing**  
Tel: 86-25-8473-2460

**China - Qingdao**  
Tel: 86-532-8502-7355

**China - Shanghai**  
Tel: 86-21-3326-8000

**China - Shenyang**  
Tel: 86-24-2334-2829

**China - Shenzhen**  
Tel: 86-755-8864-2200

**China - Suzhou**  
Tel: 86-186-6233-1526

**China - Wuhan**  
Tel: 86-27-5980-5300

**China - Xian**  
Tel: 86-29-8833-7252

**China - Xiamen**  
Tel: 86-592-2388138

**China - Zhuhai**  
Tel: 86-756-3210040

### ASIA/PACIFIC

**India - Bangalore**  
Tel: 91-80-3090-4444

**India - New Delhi**  
Tel: 91-11-4160-8631

**India - Pune**  
Tel: 91-20-4121-0141

**Japan - Osaka**  
Tel: 81-6-6152-7160

**Japan - Tokyo**  
Tel: 81-3-6880-3770

**Korea - Daegu**  
Tel: 82-53-744-4301

**Korea - Seoul**  
Tel: 82-2-554-7200

**Malaysia - Kuala Lumpur**  
Tel: 60-3-7651-7906

**Malaysia - Penang**  
Tel: 60-4-227-8870

**Philippines - Manila**  
Tel: 63-2-634-9065

**Singapore**  
Tel: 65-6334-8870

**Taiwan - Hsin Chu**  
Tel: 886-3-577-8366

**Taiwan - Kaohsiung**  
Tel: 886-7-213-7830

**Taiwan - Taipei**  
Tel: 886-2-2508-8600

**Thailand - Bangkok**  
Tel: 66-2-694-1351

**Vietnam - Ho Chi Minh**  
Tel: 84-28-5448-2100

### EUROPE

**Austria - Wels**  
Tel: 43-7242-2244-39  
Fax: 43-7242-2244-393

**Denmark - Copenhagen**  
Tel: 45-4485-5910  
Fax: 45-4485-2829

**Finland - Espoo**  
Tel: 358-9-4520-820

**France - Paris**  
Tel: 33-1-69-53-63-20  
Fax: 33-1-69-30-90-79

**Germany - Garching**  
Tel: 49-8931-9700

**Germany - Haan**  
Tel: 49-2129-3766400

**Germany - Heilbronn**  
Tel: 49-7131-72400

**Germany - Karlsruhe**  
Tel: 49-721-625370

**Germany - Munich**  
Tel: 49-89-627-144-0  
Fax: 49-89-627-144-44

**Germany - Rosenheim**  
Tel: 49-8031-354-560

**Israel - Ra'anana**  
Tel: 972-9-744-7705

**Italy - Milan**  
Tel: 39-0331-742611  
Fax: 39-0331-466781

**Italy - Padova**  
Tel: 39-049-7625286

**Netherlands - Drunen**  
Tel: 31-416-690399  
Fax: 31-416-690340

**Norway - Trondheim**  
Tel: 47-7288-4388

**Poland - Warsaw**  
Tel: 48-22-3325737

**Romania - Bucharest**  
Tel: 40-21-407-87-50

**Spain - Madrid**  
Tel: 34-91-708-08-90  
Fax: 34-91-708-08-91

**Sweden - Gothenberg**  
Tel: 46-31-704-60-40

**Sweden - Stockholm**  
Tel: 46-8-5090-4654

**UK - Wokingham**  
Tel: 44-118-921-5800  
Fax: 44-118-921-5820