

ADJUSTABLE HIGH PRECISION SHUNT REGULATOR

■ GENERAL DESCRIPTION

The NJM2380/A and NJM2390/A are adjustable high precision shunt regulators.

They are adapted for downsizing power supply module, battery charger and others, because an ultra mini package SOT23-5 is included in the package line-up.

■ FEATURES

- Operating Voltage V_{REF} to 18V
- High Precision Voltage Reference $2.465V \pm 2\%$
 $2.465V \pm 1\%$: A Version
- Mounted in Ultra Mini Package SOT23-5
- Minimum External Parts
- Bipolar Technology
- Package Outline DMP8, SOP8 JEDEC 150mil
SOT89-3, SOT23-5

■ PACKAGE OUTLINE

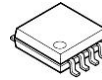

NJM2380M/AM
(DMP8)

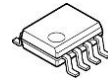

NJM2380E/AE
(SOP8)

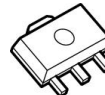

NJM2380U/AU
NJM2390U/AU
(SOT89-3)

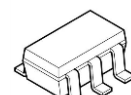

NJM2380F/AF
(SOT23-5)

■ PIN CONFIGURATION

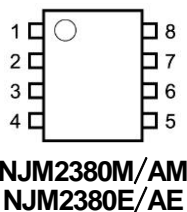

NJM2380M/AM
NJM2380E/AE

PIN FUNCTION

1. CATHODE
2. NC
3. NC
4. NC
5. NC
6. ANODE
7. NC
8. REFERENCE

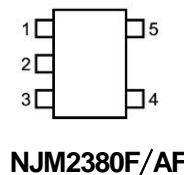

NJM2380F/AF

PIN FUNCTION

1. NC
2. ANODE
3. NC
4. CATHODE
5. REFERENCE

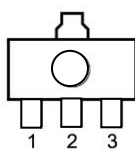

NJM2380U/AU

PIN FUNCTION

1. REFERENCE
2. ANODE
3. CATHODE

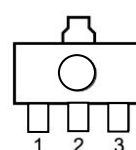

NJM2390U/AU

PIN FUNCTION

1. CATHODE
2. ANODE
3. REFERENCE

■ BLOCK DIAGRAM

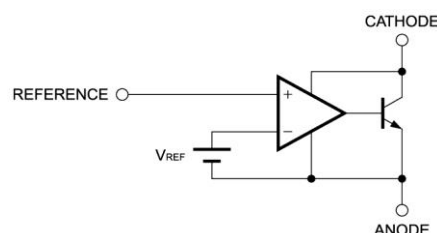

NJM2380/A, NJM2390/A

■ ABSOLUTE MAXIMUM RATINGS

($T_a=25^\circ\text{C}$)

PARAMETER	SYMBOL	RATINGS	UNIT
Cathode Voltage	V_{KA}	+20	V
Continuous Cathode Current	I_{KA}	-100 to 150	mA
Reference Input Current	I_{REF}	-0.05 to 10	mA
Power Dissipation	P_D	(DMP8) 300 (SOP8) 300 (SOT89) 350 (SOT23) 200	mW
Operating Temperature Range	T_{OPR}	-40 to +85	$^\circ\text{C}$
Storage Temperature Range	T_{STG}	-50 to +150	$^\circ\text{C}$

■ RECOMMENDED OPERATING CONDITIONS

PARAMETER	SYMBOL	MIN.	TYP.	MAX.	UNIT
Cathode Voltage	V_{KA}	V_{REF}	-	18	V
Cathode Current	I_K	1		100	mA

■ ELECTRICAL CHARACTERISTICS

($I_K=10\text{mA}$, $T_a=25^\circ\text{C}$)

PARAMETER	SYMBOL	CONDITIONS	MIN.	TYP.	MAX.	UNIT
Reference Voltage	V_{REF}	$V_{KA}=V_{REF}(*1)$	2415	2465	2515	mV
		$V_{KA}=V_{REF}(*1)$, A Version	2440	2465	2490	
Reference Voltage Change vs. Cathode Voltage Change	V_{REF}/V_{KA}	$ V_{REF} \leq V_{KA} \leq 10\text{V}(*2)$	-	± 1.4	± 2.7	mV/V
		$10 \leq V_{KA} \leq 18\text{V}(*2)$	-	± 1	± 2	mV/V
Reference Input Current	I_{REF}	$R=10\text{k}\Omega$, $R2=\infty(*2)$	-	2	4	μA
Minimum Input Current	I_{MIN}	$V_{KA}=V_{REF}(*1)$	-	0.4	1.0	mA
Cathode Current (Off Cond.)	I_{OFF}	$V_{KA}=18\text{V}$, $V_{REF}=0\text{V}(*3)$	-	0.1	1.0	μA
Dynamic Impedance	$ Z_{KA} $	$V_{KA}=V_{REF}$, $f \leq 1\text{kHz}$ $1\text{mA} \leq I_K \leq 100\text{mA}(*1)$	-	0.2	-	Ω

■ TEMPERATURE CHARACTERISTICS

($I_K=10\text{mA}$, $T_a=-20$ to $+85^\circ\text{C}$)

PARAMETER	SYMBOL	CONDITIONS	MIN.	TYP.	MAX.	UNIT
Reference Voltage Change	ΔV_{REF}	$V_{KA}=V_{REF}(*1)$	-	8	17	mV
Reference Input Current Change	ΔI_{REF}	$R1=10\text{k}\Omega$, $R2=\infty(*2)$	-	0.4	1.2	μA

The "Reference Voltage Change" and "Reference Input Current Change" is tested to using some samples of the first five lots. These "TEMPERATURE CHARACTERISTICS" are not guaranteed.

$|V_{REF}|$...Reference voltage includes error.

(*1) : TEST CIRCUIT 1 (Fig.1)

(*2) : TEST CIRCUIT 2 (Fig.2)

(*3) : TEST CIRCUIT 3 (Fig.3)

■ TEST CIRCUIT

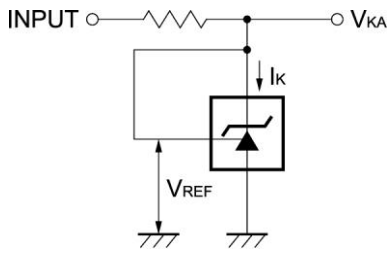

1, $V_{KA} = V_{REF}$

$$V_O = V_{KA} = V_{REF}$$

(Fig.1)

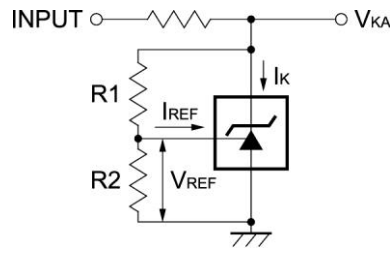

2, $V_{KA} > V_{REF}$

$$V_O = V_{KA} = V_{REF} \cdot \left(1 + \frac{R1}{R2}\right) + I_{REF} \cdot R1$$

(Fig.2)

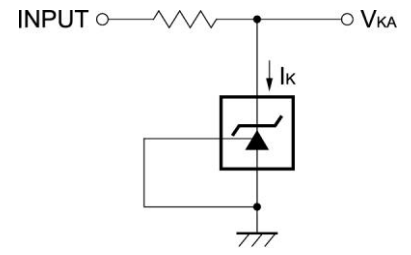

3, I_{OFF}

(Fig.3)

■ POWER DISSIPATION VS. AMBIENT TEMPERATURE

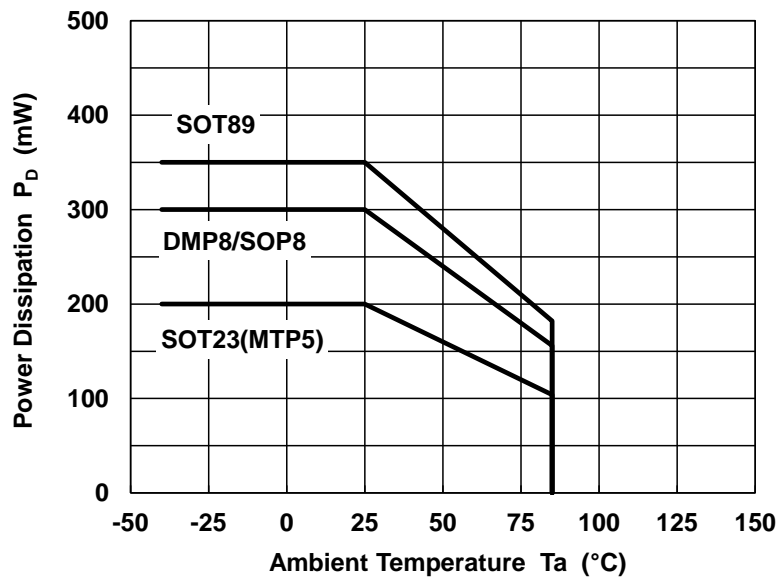

NJM2380/A, NJM2390/A

■ TYPICAL CHARACTERISTICS

Reference Voltage

($V_{KA}=V_{REF}$, $T_a=25^\circ\text{C}$)

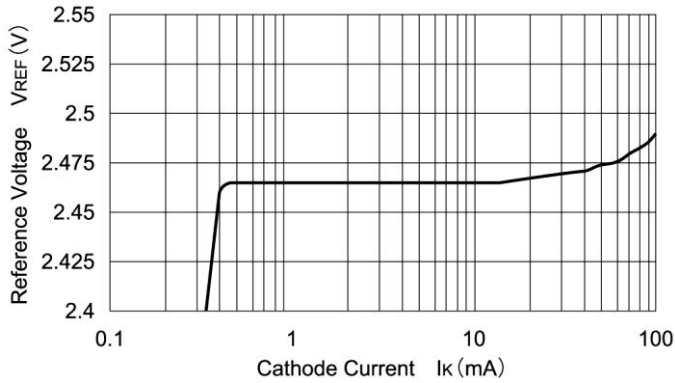

Reference Voltage

($I_k=10\text{mA}$, $R_1=\text{Variable}$, $R_2=2.5\text{k}\Omega$, $T_a=25^\circ\text{C}$)

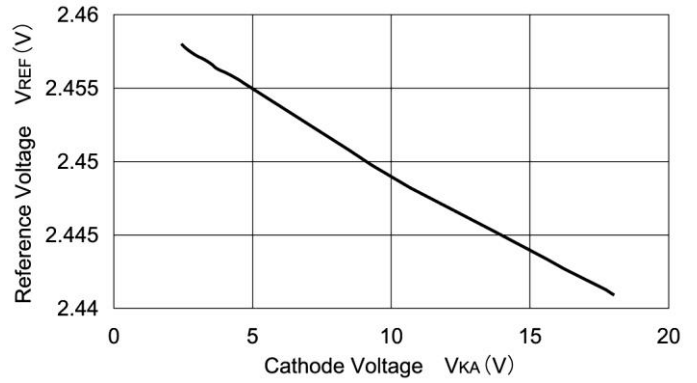

Reference Input Current

($I_k=10\text{mA}$, $R_1=10\text{k}\Omega$, $R_2=\infty$)

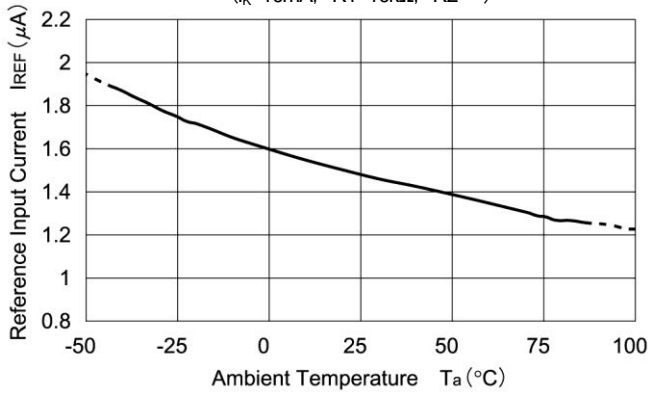

Reference Voltage

($V_{KA}=V_{REF}$, $I_k=10\text{mA}$)

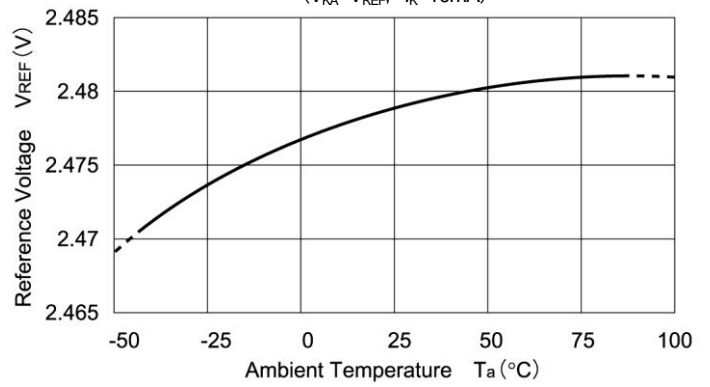

Dynamic Impedance

($I_k=10\text{mA}$, $T_a=25^\circ\text{C}$)

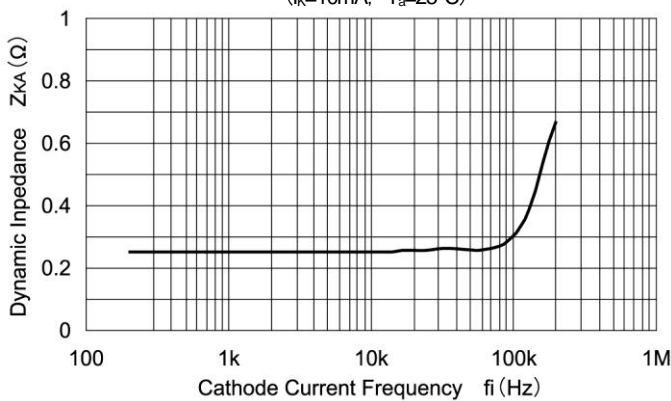

■ TYPICAL CHARACTERISTICS

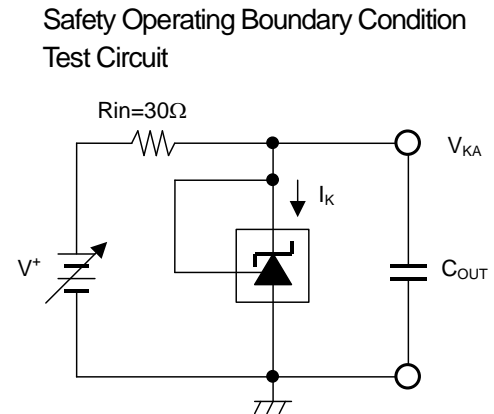
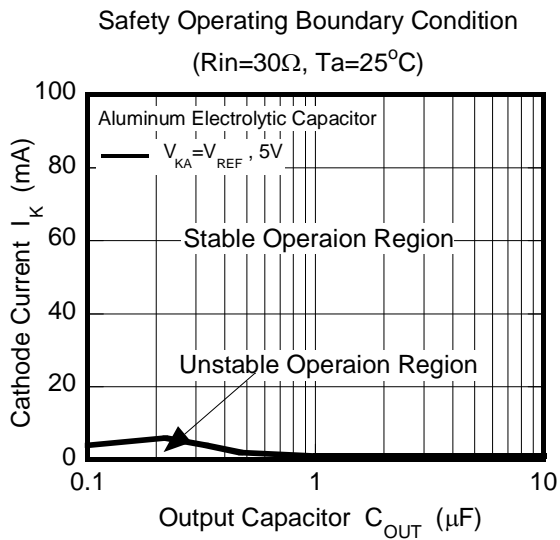

Note) Oscillation might occur while operating within the range of safety curve.
So that, it is necessary to make ample margins by taking considerations of fluctuation of the device.

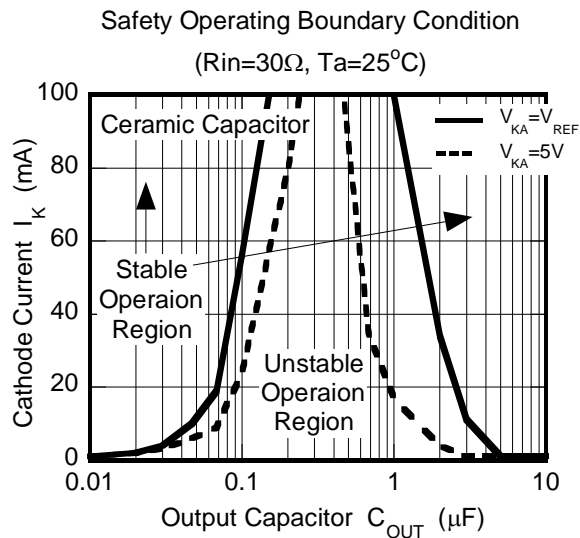

[CAUTION]

The specifications on this databook are only given for information, without any guarantee as regards either mistakes or omissions. The application circuits in this databook are described only to show representative usages of the product and not intended for the guarantee or permission of any right including the industrial rights.