

2A, 6V, 1.5MHz, 25 μ A I_Q, ACOT™ Synchronous Step-Down Converter

General Description

The RT5785A/B is a high-performance, Advanced Constant On-Time (ACOT™) monolithic synchronous step-down DC-DC converter that can deliver up to 2A output current from a 2.5V to 6V input supply. The proprietary ACOT control architecture features quick transient response and provides stable operation with small ceramic output capacitors and without complicated external compensation. The switching ripple voltage is easily smoothed-out by small package filtering elements due to a constant switching frequency of 1.5MHz and the maximum duty cycle of 100% allows the device to operate at low dropout use. With internal low on-resistance power switches and extremely low quiescent current, the RT5785A/B displays excellent efficiency and good behavior across a range of applications.

Cycle-by-cycle current limit provides protection against shorted outputs, input under-voltage lock-out, output under-voltage protection, and thermal shutdown provide safe and smooth operation in all operating conditions. The RT5785A/B is available in the TSOT-23-8 (FC) package.

Features

- Dramatically Fast Transient Response
- Steady 1.5MHz \pm 200kHz Switching Frequency
- Very Low Input Quiescent and Shutdown Currents
- Advanced COT Control Loop Design
- Optimized for Ceramic Output Capacitors
- 2.5V to 6V Input Voltage Range
- Accurate Voltage Reference 0.6V \pm 2%
- Integrated 100m Ω /60m Ω MOSFETs
- Internal Start-Up into Pre-Biased Outputs
- Power Good Indicator
- Enable Control
- Over-Current and Over-Temperature Protections
- Under-Voltage Protection with Hiccup Mode
- RoHS Compliant and Halogen Free

Applications

- Mobile Phones and Handheld Devices
- STB, Cable Modem, and xDSL Platforms
- WLANASIC Power / Storage (SSD and HDD)
- General Purpose for POL LV Buck Converter

Simplified Application Circuit

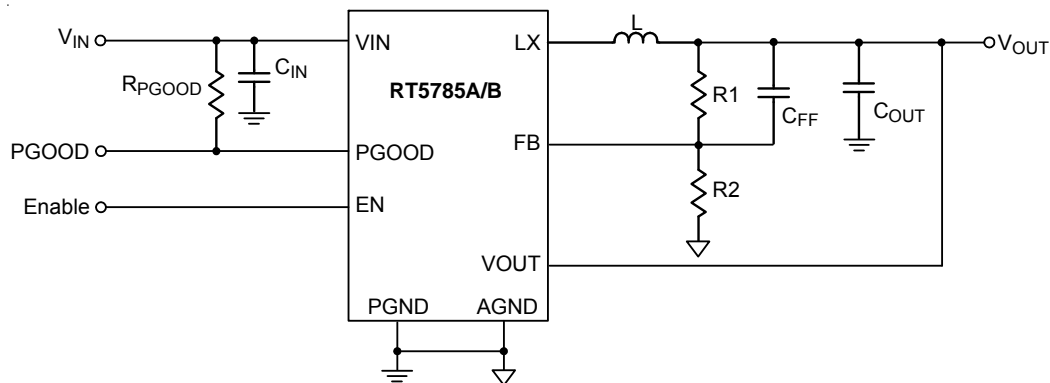

Ordering Information

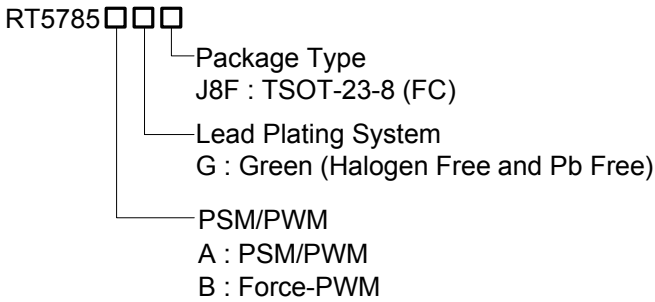

Note :

Richtek products are :

- ▶ RoHS compliant and compatible with the current requirements of IPC/JEDEC J-STD-020.
- ▶ Suitable for use in SnPb or Pb-free soldering processes.

Pin Configuration

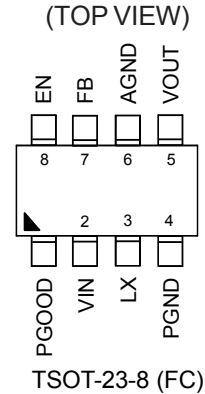

Marking Information

RT5785AGJ8F

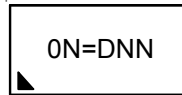

0N= : Product Code

DNN : Date Code

RT5785BGJ8F

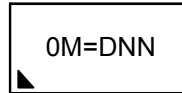

0M= : Product Code

DNN : Date Code

Functional Pin Description

Pin No.	Pin Name	Pin Function
1	PGOOD	Power good indicator output. This pin is an open-drain logic output that is pulled to ground when the output voltage is lower or higher than its specified threshold under the conditions of UVP, OTP, dropout, EN shutdown, or during slow start.
2	VIN	Supply input. Supplies the power to the internal control circuit as well as the power switches of the device. Drive VIN with a 2.5V to 6V power source and bypass VIN to PGND with a suitably large capacitor to eliminate noise on the input to the IC.
3	LX	Switch node. LX is the switching node that supplies power to the output and connect the output LC filter from LX to the output load.
4	PGND	Power ground. This pin must be soldered to a large PCB and connected to analog ground for maximum power dissipation.
5	VOUT	Output voltage sense input. This pin is used to monitor and adjust output voltage for superior load transient regulation.
6	AGND	Analog ground. Provides the ground return path for control circuitry and internal reference.
7	FB	Feedback voltage input. This pin is used to set the desired output voltage via an external resistive divider. The feedback reference voltage is 0.6V typically.
8	EN	Enable control input. Connecting this pin to logic high can enable the device and connecting this pin to GND can disable the device.

Functional Block Diagram

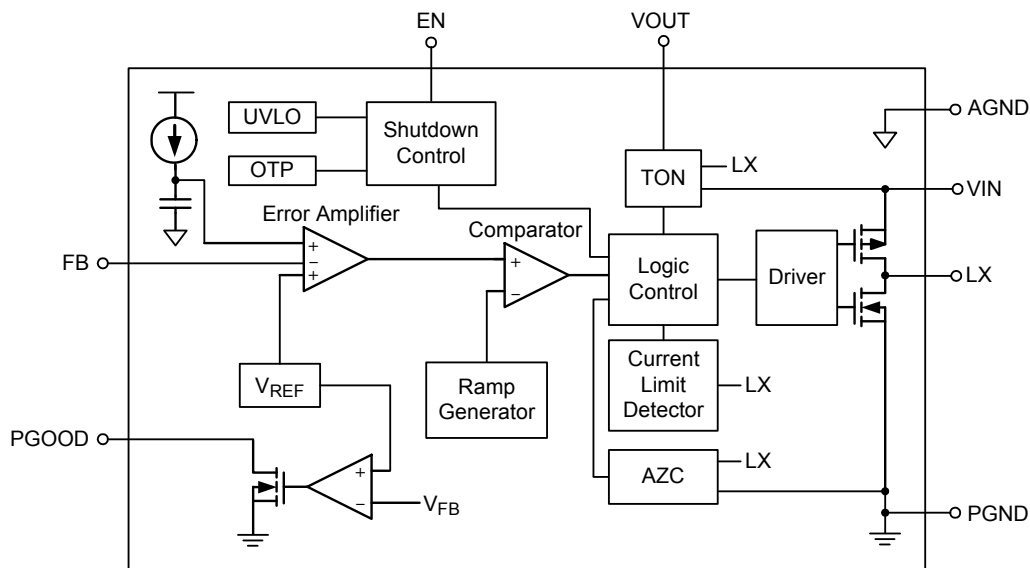

Operation

The RT5785A/B is a low voltage synchronous step-down converter that can support input voltage ranging from 2.5V to 6V and the output current can be up to 2A. The RT5785A/B uses ACOT™ mode control. To achieve good stability with low-ESR ceramic capacitors, the ACOT uses a virtual inductor current ramp generated inside the IC. This internal ramp signal replaces the ESR ramp normally provided by the output capacitor's ESR. The ramp signal and other internal compensations are optimized for low-ESR ceramic output capacitors.

In steady-state operation, the feedback voltage, with the virtual inductor current ramp added, is compared to the reference voltage. When the combined signal is less than the reference, the on-time one-shot is triggered, as long as the minimum off-time one-shot is clear and the measured inductor current (through the synchronous rectifier) is below the current limit. The on-time one-shot turns on the high-side switch and the inductor current ramps up linearly. After the on-time, the high-side switch is turned off and the synchronous rectifier is turned on and the inductor current ramps down linearly. At the same time, the minimum off-time one-shot is triggered to prevent

another immediate on-time during the noisy switching time and allow the feedback voltage and current sense signals to settle. The minimum off-time is kept short so that rapidly-repeated on-times can raise the inductor current quickly when needed.

Under-Voltage Protection (UVLO)

The UVLO continuously monitors the VCC voltage to make sure the device works properly. When the VCC is high enough to reach the UVLO high threshold voltage, the step-down converter softly starts or pre-bias to its regulated output voltage. When the VCC decreases to its low threshold voltage, the device shuts down.

Power Good

When the output voltage is higher than PGOOD rising threshold, the PGOOD flag is high.

Output Under-Voltage Protection (UVP)

When the output voltage is lower than 66% reference voltage after soft-start, the UVP is triggered.

Over-Current Protection (OCP)

The RT5785A/B senses the current signal when the high-side and low-side MOSFET turns on. As a result, The OCP is a cycle-by-cycle current limit. If an over-current condition occurs, the converter turns off the next on pulse until inductor current drops below the OCP limit. The delay time of high-side MOSFET OCP trigger is 100ns. If the OCP is continually activated and the load current is larger than the current provided by the converter, the output voltage drops. Also, when the output voltage triggers the UVP also, the current will drop to ZC and trigger the re-soft-start sequence.

Soft-Start

An internal current source charges an internal capacitor to build the soft-start ramp voltage. The typical soft-start time is 1.5ms.

Over-Temperature Protection (OTP)

The RT5785A/B has an over-temperature protection. When the device triggers the OTP, the device shuts down until the temperature is back to normal.

PWM Frequency and Adaptive On-Time Control

The on-time can be roughly estimated by the equation :

$$T_{ON} = \frac{V_{OUT}}{V_{IN}} \times \frac{1}{f_{OSC}} \text{ where } f_{OSC} \text{ is nominal } 1.5\text{MHz}$$

Absolute Maximum Ratings (Note 1)

- Supply Input Voltage, V_{IN} ----- -0.3V to 7V
- LX Pin Switch Voltage ----- -0.3V to 7.3V
 <10ns ----- -2V to 8.5V
- Other Pins ----- -0.3V to 5V
- Power Dissipation, P_D @ $T_A = 25^\circ\text{C}$
 TSOT-23-8 (FC) ----- 1.429W
- Package Thermal Resistance (Note 2)
 TSOT-23-8 (FC), θ_{JA} ----- 70°C/W
 TSOT-23-8 (FC), θ_{JC} ----- 15°C/W
- Junction Temperature ----- 150°C
- Lead Temperature (Soldering, 10 sec.) ----- 260°C
- Storage Temperature Range ----- -65°C to 150°C
- ESD Susceptibility (Note 3)
 HBM (Human Body Model) ----- 2kV

Recommended Operating Conditions (Note 4)

- Supply Input Voltage, V_{IN} ----- 2.5V to 6V
- Junction Temperature Range ----- -40°C to 125°C
- Ambient Temperature Range ----- -40°C to 85°C

Electrical Characteristics

($V_{IN} = 5\text{V}$, $T_A = 25^\circ\text{C}$, unless otherwise specified)

Parameter	Symbol	Test Conditions	Min	Typ	Max	Unit
Supply Voltage						
Input Operating Voltage	V_{IN}		2.5	--	6	V
Under-Voltage Lockout Threshold Rising	V_{UVLO}		2.15	2.3	2.45	
Under-Voltage Lockout Threshold Hysteresis	ΔV_{UVLO}		--	260	--	mV
Shutdown Current	I_{SHDN}	$V_{EN} = 0\text{V}$	--	0	1	μA
Quiescent Current	I_Q	For RT5785A V_{LX} no switching	--	25	--	
		RT5785B	--	600	--	
Enable Voltage						
Enable Threshold Voltage	V_{IH}	V_{EN} rising	1.2	--	--	V
	V_{IL}	V_{EN} falling	--	--	0.4	
Feedback Voltage						
Feedback Voltage	V_{FB}	$2.5\text{V} \leq V_{IN} \leq 5.5\text{V}$	0.588	0.6	0.612	V
Feedback Input Current	I_{FB}	$V_{FB} = 0.6\text{V}$	--	10	--	nA

Parameter	Symbol	Test Conditions	Min	Typ	Max	Unit
Current Limit						
High-Side Switch Peak Current Limit	I_{LIM_H}		2.8	3.2	4.2	A
Low-Side Switch Valley Current Limit	I_{LIM_L}		2	2.5	3.4	
Switching						
Switching Frequency	f_S	$V_{OUT} = 1.2V$	1300	1500	1700	kHz
Minimum Off-Time			--	60	--	ns
Internal MOSFET						
High-Side On-Resistance	$R_{DS(ON)_H}$		--	100	--	m Ω
Low-Side On-Resistance	$R_{DS(ON)_L}$		--	60	--	
Switch Leakage Current		$V_{EN} = 0V, V_{IN} = 5.5V, V_{LX} = 0V$ and $5.5V$	--	0	1	μA
Soft-Start						
Fixed Soft-Start Time	T_{SS}	EN from low to high and V_{OUT} is meet 95%	1.1	1.7	--	ms
Power Good						
Power Good Rising Threshold		V_{FB} rising (Good)	--	95	--	% V_{FB}
		V_{FB} rising (Fault)	--	110	--	
Power Good Falling Threshold		V_{FB} falling (Fault)	--	90	--	
		V_{FB} falling (Good)	--	105	--	
Power Good Enable Delay Time			--	50	--	μs
Power Good Sink Current Capability		I_{PGOOD} sinks 1mA	--	--	0.4	V
Power Good Internal Resistance			--	550	--	k Ω
Power Good Asserting Voltage	V_{PGOOD}	$V_{IN} = 5V, V_{FB} = 0.6V$	4.9	--	--	V
Over-Temperature Protection						
Thermal Shutdown	T_{SD}		--	150	--	$^{\circ}C$
Thermal Shutdown Hysteresis	ΔT_{SD}		--	30	--	

Note 1. Stresses beyond those listed “Absolute Maximum Ratings” may cause permanent damage to the device. These are stress ratings only, and functional operation of the device at these or any other conditions beyond those indicated in the operational sections of the specifications is not implied. Exposure to absolute maximum rating conditions may affect device reliability.

Note 2. θ_{JA} is measured at $T_A = 25^{\circ}C$ on a high effective thermal conductivity four-layer test board per JEDEC 51-7. The first layer of copper area is filled.

Note 3. Devices are ESD sensitive. Handling precaution is recommended.

Note 4. The device is not guaranteed to function outside its operating conditions.

Typical Application Circuit

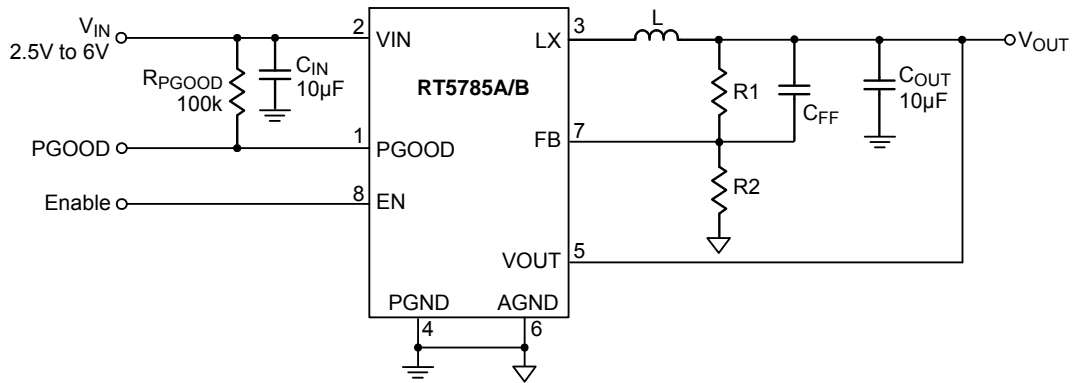
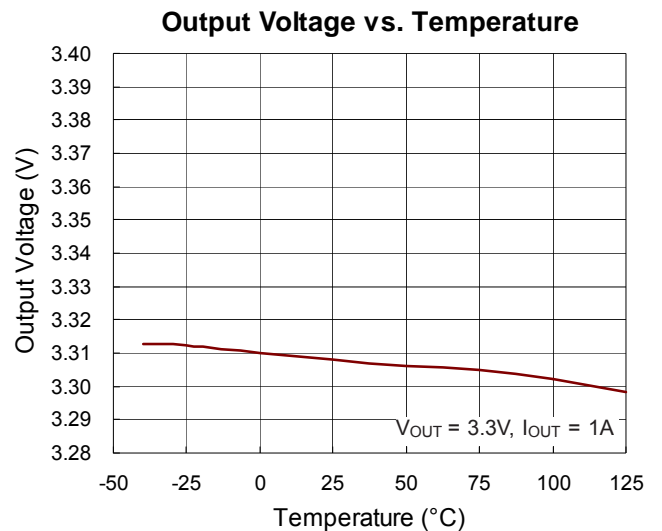
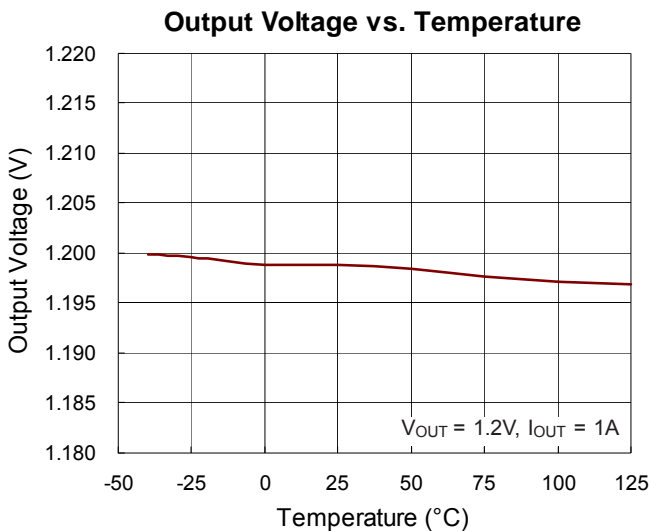
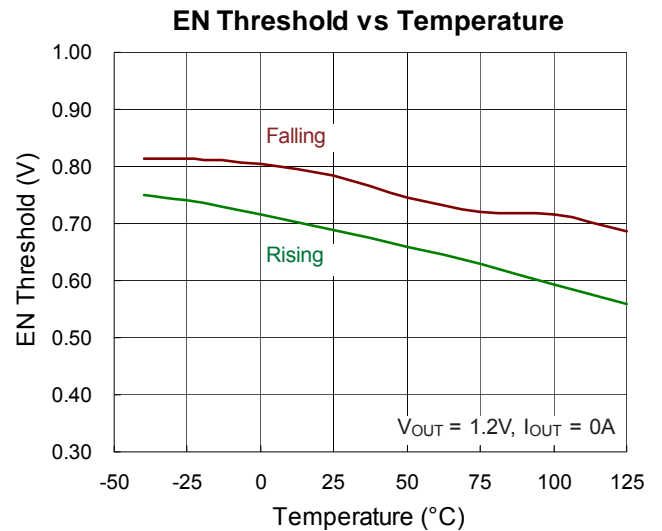
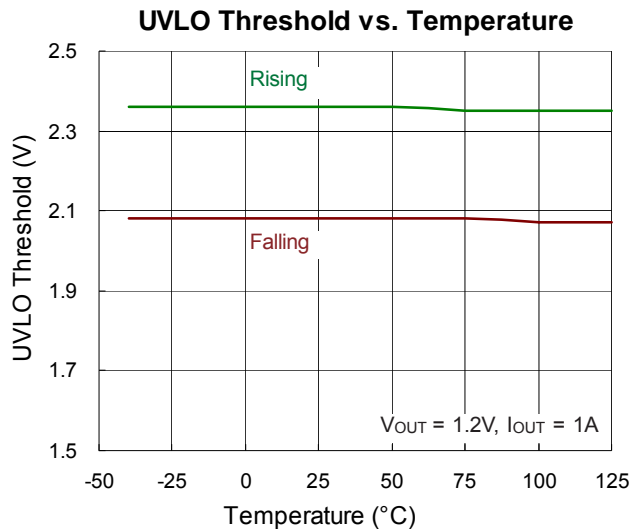
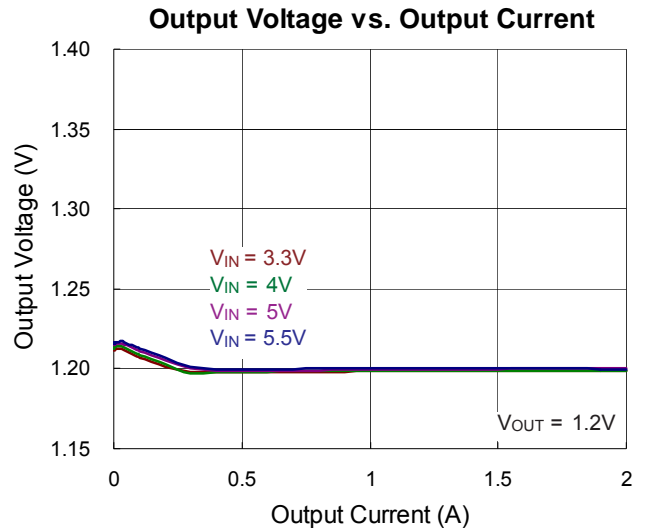
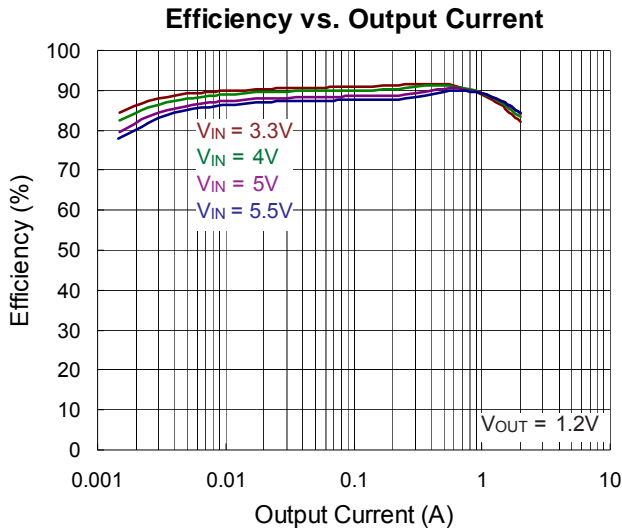

Table 1. Suggested Component Values

V _{OUT} (V)	R ₁ (kΩ)	R ₂ (kΩ)	L (µH)	C _{OUT} (µF)
1	200	300	1	10
1.2	200	200	1	10
1.8	200	100	1.4	10
2.5	200	63.2	1.4	10
3.3	200	44.2	1.4	10

Typical Operating Characteristics



Reference Voltage vs. Temperature

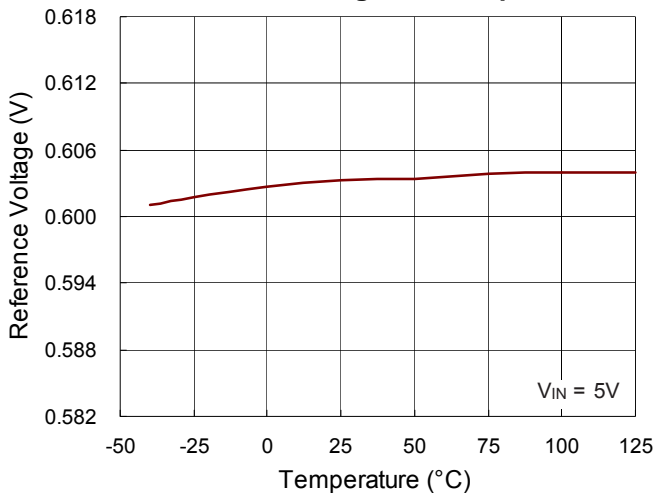

Soft-Start Time vs. Temperature

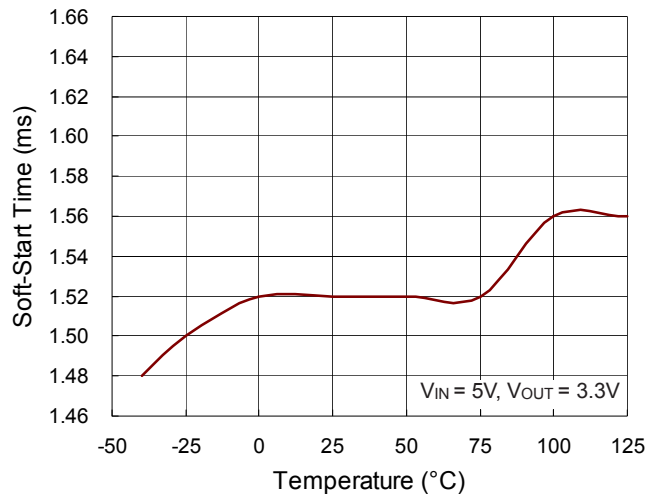

Load Transient Response

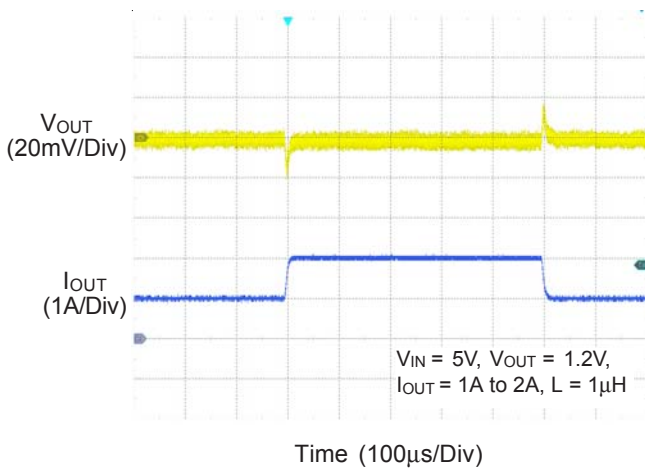

Output Ripple Voltage

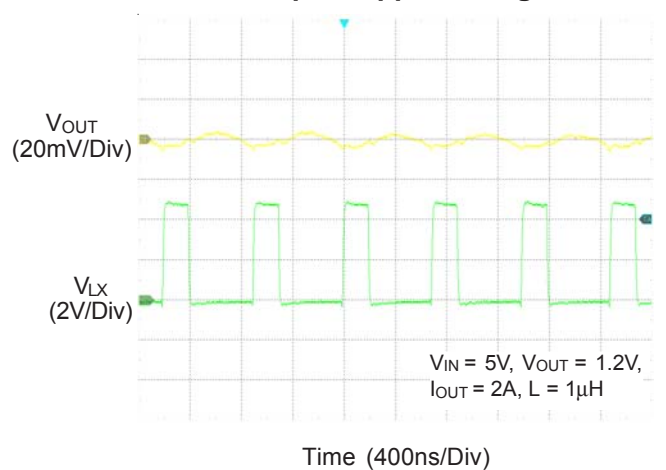

Power On from VIN

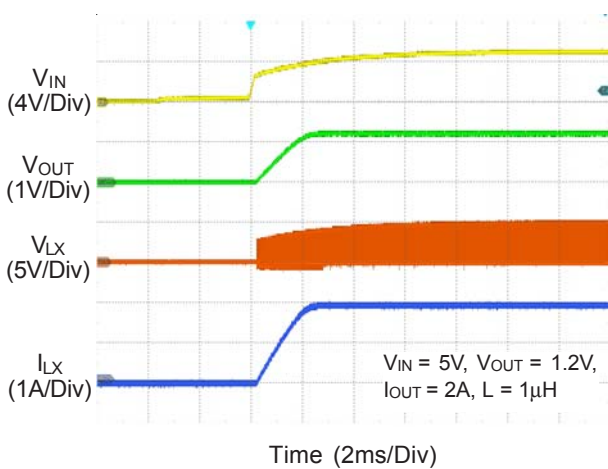

Power Off from VIN

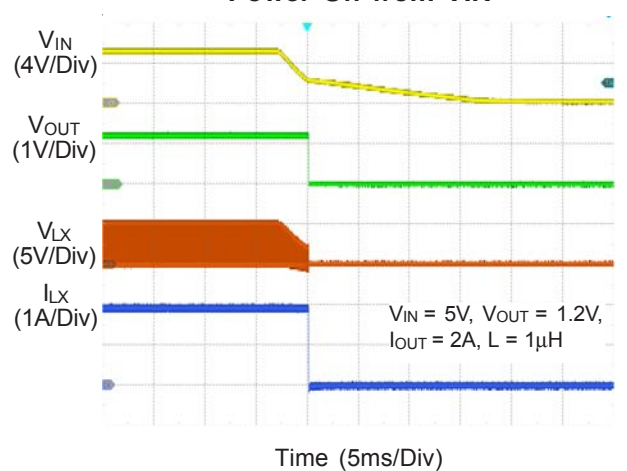

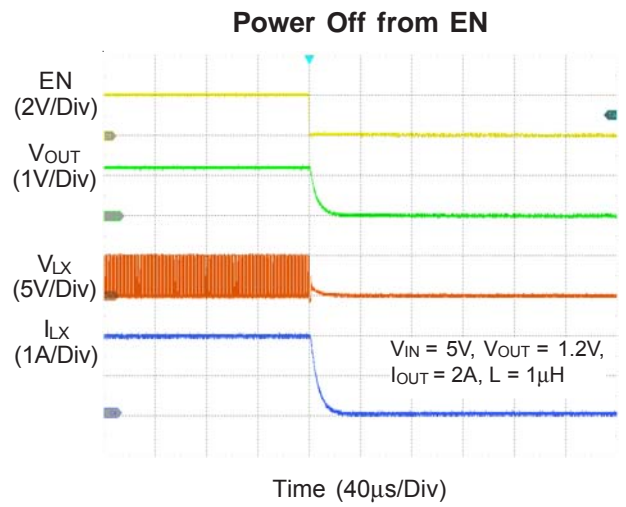
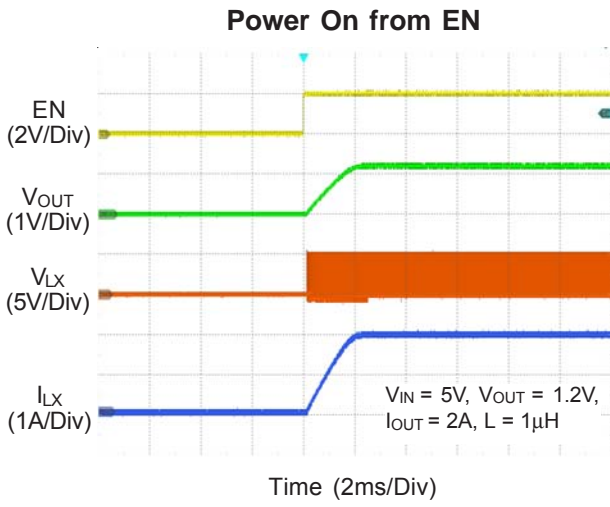

Application Information

The RT5785A/B is a single-phase step-down converter. Advance Constant-on-Time (ACOT) with fast transient response. An internal 0.6V reference allows the output voltage to be precisely regulated for low output voltage applications. A fixed switching frequency (1.5MHz) oscillator and internal compensation are integrated to minimize external component count. Protection features include over current protection, under voltage protection and over temperature protection.

Inductor Selection

The consideration of inductor selection includes inductance, RMS current rating and, saturation current rating. The inductance selection is generally flexible and is optimized for the low cost, low physical size, and high system performance.

Choosing lower inductance to reduce physical size and cost, and it is useful to improve the transient response. However, it causes the higher inductor peak current and output ripple voltage to decrease system efficiency. Conversely, higher inductance increase system efficiency, but the physical size of inductor will become larger and transient response will be slow because more transient time is required to change current (up or down) by inductor. A good compromise between size, efficiency, and transient response is to set a inductor ripple current (ΔI_L) about 20% to 50% of the desired full output load current.

Calculate the approximate inductance by the input voltage, output voltage, switching frequency (f_{SW}), maximum rated output current ($I_{OUT(MAX)}$) and inductor ripple current (ΔI_L).

$$L = \frac{V_{OUT} \times (V_{IN} - V_{OUT})}{V_{IN} \times f_{SW} \times \Delta I_L}$$

Once the inductance is chosen, the inductor ripple current (ΔI_L) and peak inductor current can be calculated.

$$\Delta I_L = \frac{V_{OUT} \times (V_{IN} - V_{OUT})}{V_{IN} \times f_{SW} \times L}$$

$$I_{L(PEAK)} = I_{OUT(MAX)} + \frac{1}{2} \Delta I_L$$

$$I_{L(VALLY)} = I_{OUT(MAX)} - \frac{1}{2} \Delta I_L$$

For the typical operating circuit design, the output voltage is 1.2V, maximum rated output current is 2A, input voltage is 5V, and inductor ripple current is 0.6A which is 30% of the maximum rated output current, the calculated inductance value is :

$$L = \frac{1.2 \times (5 - 1.2)}{5 \times 1500 \times 10^3 \times 0.6} = 1\mu H$$

The inductor ripple current set at 0.6A and so we select 1μH inductance. The actual inductor ripple current and required peak current is shown as below :

$$\Delta I_L = \frac{1.2 \times (5 - 1.2)}{5 \times 1500 \times 10^3 \times 1 \times 10^{-6}} = 0.6A$$

$$I_{L(PEAK)} = I_{OUT(MAX)} + \frac{1}{2} \Delta I_L = 2 + \frac{0.6}{2} = 2.3A$$

Inductor saturation current should be chosen over IC's current limit.

Output Voltage Setting

The output voltage is set by an external resistive divider according to the following equation :

$$V_{OUT} = V_{REF} \times \left(1 + \frac{R1}{R2}\right)$$

where VREF equals to 0.6V typical. The resistive divider allows the FB pin to sense a fraction of the output voltage as shown in Figure 1.

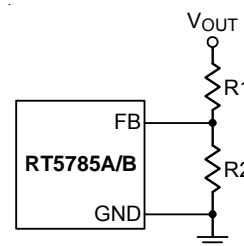

Figure 1. Setting the Output Voltage

Low Supply Operation

The RT5785A/B is designed to operate down to an input supply voltage of 2.5V. One important consideration at low input supply voltages is that the $R_{DS(ON)}$ of the P-Channel and N-Channel power switches increases. The user should calculate the power dissipation when the RT5785A/B is used at 100% duty cycle with low input voltages to ensure that thermal limits are not exceeded.

Under Voltage Protection (UVP)

Hiccup Mode

For the RT5785A/B, it provides Hiccup Mode Under Voltage Protection (UVP). When the output voltage is lower than 66% reference voltage after soft-start, the UVP is triggered. If the UVP condition remains for a period, the RT5785A/B will retry automatically. When the UVP condition is removed, the converter will resume operation. The UVP is disabled during soft-start period.

C_{IN} and C_{OUT} Selection

The input capacitance, C_{IN} , is needed to filter the trapezoidal current at the source of the top MOSFET. To prevent large ripple voltage, a low ESR input capacitor sized for the maximum RMS current should be used. RMS current is given by :

$$I_{RMS} = I_{OUT(MAX)} \frac{V_{OUT}}{V_{IN}} \sqrt{\frac{V_{IN}}{V_{OUT}} - 1}$$

This formula has a maximum at $V_{IN} = 2V_{OUT}$, where $I_{RMS} = I_{OUT} / 2$. This simple worst case condition is commonly used for design because even significant deviations do not result in much difference. Choose a capacitor rated at a higher temperature than required.

Several capacitors may also be paralleled to meet size or height requirements in the design.

The selection of C_{OUT} is determined by the effective series resistance (ESR) that is required to minimize voltage ripple and load step transients, as well as the amount of bulk capacitance that is necessary to ensure that the control loop is stable. Loop stability can be checked by viewing the load transient response. The output ripple, ΔV_{OUT} , is determined by :

$$\Delta V_{OUT} \leq \Delta I_L \left[ESR + \frac{1}{8fC_{OUT}} \right]$$

The output ripple is highest at maximum input voltage since ΔI_L increases with input voltage. Multiple capacitors placed in parallel may be needed to meet the ESR and RMS current handling requirements. Dry tantalum, special polymer, aluminum electrolytic and ceramic capacitors are all available in surface mount packages. Special polymer capacitors offer very low ESR, but have lower capacitance density than other types. Tantalum capacitors have the highest capacitance density, but it is important to only use types that have been surge tested for use in switching power supplies. Aluminum electrolytic capacitors have significantly higher ESR, but can be used in cost-sensitive applications provided that consideration is given to ripple current ratings and long term reliability. Ceramic capacitors have excellent low ESR characteristics, but can have a high voltage coefficient and audible piezoelectric effects.

The high Q of ceramic capacitors with trace inductance can also lead to significant ringing.

Using Ceramic Input and Output Capacitors

Higher value, lower cost ceramic capacitors are now becoming available in smaller case sizes. Their high ripple current, high voltage rating and low ESR make them ideal for switching regulator applications. However, care must be taken when these capacitors are used at the input and output. When a ceramic capacitor is used at the input and the power is supplied by a wall adapter through long wires, a load step at the output can induce ringing at the input, V_{IN} . At best, this ringing can couple to the output and be mistaken as loop instability. At worst, a sudden inrush of current through the long wires can potentially cause a voltage spike at V_{IN} large enough to damage the part.

Table 1. Capacitors for C_{IN} and C_{OUT}

Component Supplier	Part No.	Capacitance (μF)	Case Size
MuRata	GRM31CR71A106KA01	10 μF	1206

Thermal Considerations

For continuous operation, do not exceed absolute maximum junction temperature. The maximum power dissipation depends on the thermal resistance of the IC package, PCB layout, rate of surrounding airflow, and difference between junction and ambient temperature. The maximum power dissipation can be calculated by the following formula :

$$P_{D(MAX)} = (T_{J(MAX)} - T_A) / \theta_{JA}$$

where $T_{J(MAX)}$ is the maximum junction temperature, T_A is the ambient temperature, and θ_{JA} is the junction to ambient thermal resistance.

For recommended operating condition specifications, the maximum junction temperature is 125°C. The junction to ambient thermal resistance, θ_{JA} , is layout dependent. The junction to ambient thermal resistance, θ_{JA} , is layout dependent. For TSOT-23-8 (FC) package, the thermal resistance, θ_{JA} , is 70°C/W on a standard JEDEC 51-7 four-layer thermal test board. The first layer of copper area is filled. The maximum power dissipation at $T_A = 25^\circ\text{C}$ can be calculated by the following formula :

$$P_{D(MAX)} = (125^\circ\text{C} - 25^\circ\text{C}) / (70^\circ\text{C/W}) = 1.429\text{W for TSOT-23-8 (FC) package}$$

The maximum power dissipation depends on the operating ambient temperature for fixed $T_{J(MAX)}$ and thermal resistance, θ_{JA} . The derating curve in Figure 2 allows the designer to see the effect of rising ambient temperature on the maximum power dissipation.

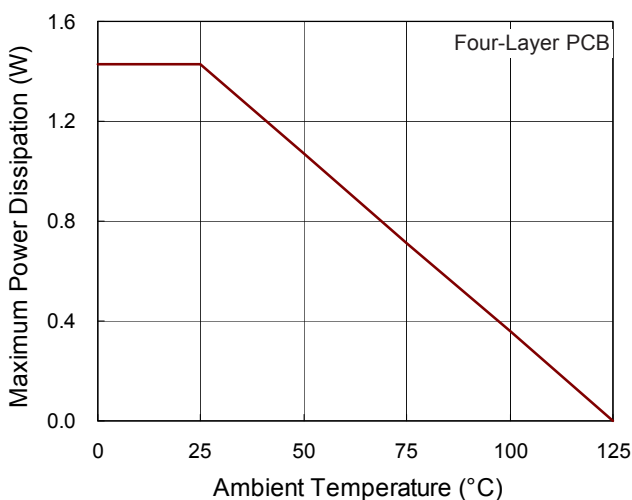
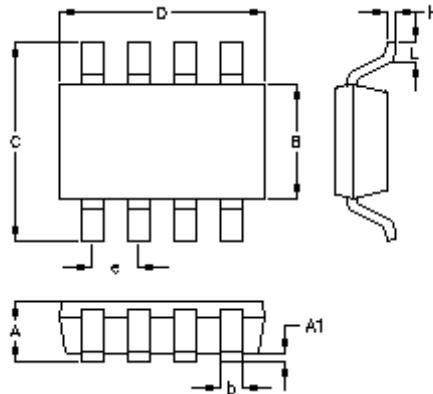

Figure 2. Derating Curve of Maximum Power Dissipation

Outline Dimension



Symbol	Dimensions In Millimeters		Dimensions In Inches	
	Min.	Max.	Min.	Max.
A	0.700	1.000	0.028	0.039
A1	0.000	0.100	0.000	0.004
B	1.397	1.803	0.055	0.071
b	0.220	0.380	0.009	0.015
C	2.591	3.000	0.102	0.118
D	2.692	3.099	0.106	0.122
e	0.585	0.715	0.023	0.028
H	0.080	0.254	0.003	0.010
L	0.300	0.610	0.012	0.024

TSOT-23-8 (FC) Surface Mount Package

Richtek Technology Corporation

14F, No. 8, Tai Yuen 1st Street, Chupei City
 Hsinchu, Taiwan, R.O.C.
 Tel: (8863)5526789

Richtek products are sold by description only. Customers should obtain the latest relevant information and data sheets before placing orders and should verify that such information is current and complete. Richtek cannot assume responsibility for use of any circuitry other than circuitry entirely embodied in a Richtek product. Information furnished by Richtek is believed to be accurate and reliable. However, no responsibility is assumed by Richtek or its subsidiaries for its use; nor for any infringements of patents or other rights of third parties which may result from its use. No license is granted by implication or otherwise under any patent or patent rights of Richtek or its subsidiaries.